

ISSA Prevention Series No. 2033 (E)



**International Section
for Machine and
System Safety**

Dust Explosion Prevention and Protection for Machines and Equipment

**Basic
Principles**



**International Section
of the ISSA for Machine
and System Safety**

**Berufsgenossenschaft
Nahrungsmittel und Gaststätten
Dynamostraße 7-11
D-68165 Mannheim
Deutschland**

2004
ISBN 92-843-7129-5
ISSN 1015-8022



THE INTERNATIONAL SOCIAL SECURITY ASSOCIATION (ISSA)

has over 350 members (government bodies and institutes) in nearly 150 countries half of which are concerned with occupational safety. The ISSA is based in Geneva in the International Labour Organization. Its principal aim is the promotion and development of SOCIAL SECURITY the world over.

To improve occupational safety and health protection in plants, the



INTERNATIONAL SECTION OF THE ISSA FOR MACHINE AND SYSTEM SAFETY

was formed in 1975. It deals with questions concerning the safety of machines, installations, and systems. The Chair and the Secretariat are located at the headquarters of the Berufsgenossenschaft Nahrungsmittel und Gaststätten (professional association of the food and catering industry), D-68165 Mannheim, Germany.

To emphasize occupational safety in plants in the chemical industry, including the plastics, explosives, oil, and rubber industries, the



INTERNATIONAL SECTION OF THE ISSA FOR THE PREVENTION OF OCCUPATIONAL RISKS IN THE CHEMICAL INDUSTRY

was formed in 1970. The Chair and Secretariat are located at the headquarters of the Berufsgenossenschaft der chemischen Industrie (professional association of the chemical industry), D-69115 Heidelberg, Germany.

Dust Explosion Prevention and Protection for Machines and Equipment

Basic Principles

Publisher

International Section of the ISSA
for Machine and System Safety
Dynamostr. 7-11
D-68165 Mannheim, Germany

Preface

The “Machine and System Safety” Section of the Special Commission on Prevention of the International Social Security Association (ISSA) has established several working parties to handle the question of safety of machines, installations, and systems. Working party members are international experts not only from universities and research institutions but to a large extent also from industrial enterprises and the prevention departments of accident insurers. This ensures that practice-oriented proposals for solutions are developed not only for straightforward but also complex questions relevant to safety.

In this connection explosion protection is a specific area of responsibility which is handled by the “Dust Explosions” working party of the Section. The present new edition of “Dust Explosion Prevention and Protection for Machines and Equipment” brings together the most up-to-date state of knowledge relating to preventive and constructional protection measures.

The purpose of this brochure is to provide persons in charge of plant installation but without specialized knowledge of the field of explosion protection with the information to evaluate possible dust explosion hazards in their plants. It can also be used as a source of reference in relation to the requirements under EU law for plants to document hazard analyses and solutions to problems. However, individual explosion protection measures must be identified on the spot and not without the participation of experts.

The “Machine and System Safety” Section thus contributes to the maintenance and further development of a high and - through the active cooperation of the members of its working parties in commissions of the EU - comparable technological development among industrial countries. Thanks to its appreciation of the comprehensive, worldwide importance of effective prevention, the Section can also offer support and guidance in developing countries.

“Machine and System Safety” Section

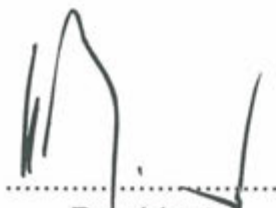

.....
President
(Dr F. Mosetter)



.....
Secretary General
(Dr H.-J. Bischoff)

Chairman

Prof. Dr S. Radandt
FSA (Research Centre for Applied System Safety and Industrial Medicine)

With contributions from

Berufsgenossenschaftliches Institut für Arbeitssicherheit (BIA), Sankt Augustin	(D)
Berufsgenossenschaft der chemischen Industrie, Heidelberg	(D)
Berufsgenossenschaft Nahrungsmittel und Gaststätten (BGN), Mannheim	(D)
Kidde-Deugra Brandschutzsysteme GmbH, Ratingen	(D)
FSA (Research Centre for Applied System Safety and Industrial Medicine), Mannheim	(D)
Health and Safety Laboratory, Buxton	(GB)
StuvEx International Belgium, Kontich	(B)
Pellmont Explosionsschutz, Binningen	(CH)
FireEx Consultant GmbH, Giebenach	(CH)
Suva (Swiss National Accident Insurance Fund), Lucerne	(CH)

Authors

Dr W. Bartknecht, Freiburg	(D)	Dr G. Pellmont, Binningen	(CH)
Dipl.-Ing. H. Beck, Sankt Augustin	(D)	Dipl.-Ing. R. Siwek,	
Dr B. Dyrba, Heidelberg	(D)	Giebenach	(CH)
Dr F. Hauert, Mannheim	(D)	Ir. G. van Laar, Kontich	(B)
Ing. H. B. Janssens, Kontich	(B)	Dr Ing. K. van Wingerden, Ratingen	(D)
Dr G. Lunn, Buxton	(GB)	Dipl.-Ing. C. Zockoll, Dortmund	(D)
Dr R. J. Ott, Lucerne	(CH)		

Layout and graphic design

Dr R. J. Ott, Lucerne	(CH)
Dipl.-Designer D. Settele (computer graphics)	(D)

Contents

1. Introduction	8
2. Explosion prevention	10
2.1 Avoiding explosive dust/air mixtures	10
2.1.1 Eliminating combustible dusts	10
2.1.2 Limiting the concentration of combustible dusts	10
2.2 Limiting the oxygen concentration	11
2.2.1 Inerting with gases	11
2.2.2 Inerting with solids	16
2.2.3 Use of vacuum	16
2.3 Avoiding effective ignition sources	17
3. Constructional explosion protection	31
3.1 Explosion-resistant design	32
3.2 Explosion venting	32
3.3 Explosion suppression	36
3.4 Explosion decoupling, isolation (prevention of explosion propagation)	36
3.4.1 Rotary valves	37
3.4.2 Extinguishing barriers	38
3.4.3 Rapid-action gate valves	39
3.4.4 Rapid-action barrier valves	40
3.4.5 Explosion diverters	42
4. Appendix 44	
4.1 Terms, definitions and abbreviations	44
4.2 References	47
5. ISSA publications on explosion protection	49

1 Introduction

The purpose of the present document is to describe the possible explosion hazards that can occur with machines and equipment in the presence of combustible dusts, to describe possible preventive and protective measures based on state-of-the-art technology, and to provide a basis for decisions concerning their application.

A prerequisite for ignition and propagation of combustion is the simultaneous presence at one and the same location of:

- a substance capable of exothermic oxidation,
- sufficient oxygen, and
- an effective ignition source.

In addition to the above conditions, the following are necessary if an explosion is to occur:

- sufficient fineness of the combustible material
- concentration of the material in the dust/air mixture within the explosion limits.

All measures which eliminate at least one of the three prerequisites, or reduce it to such an extent that a fire or explosion can be ruled out, are referred to as **explosion prevention measures**.

If explosion prevention measures are insufficient to guarantee safety, **constructional explosion protection measures** must be applied.

These measures do not prevent a fire or explosion from occurring, but limit its effects to a harmless level.

Constructional explosion protection measures are:

- explosion-resistant design
- explosion venting
- explosion suppression
- explosion decoupling (isolation)

If risks are still present after explosion prevention and protection measures have been applied then, the installations must be brought into a non-hazardous state, e.g. by switching off the power supply.

Dust fires and dust explosions can take place during, for example:

- crushing and drying of coal and the filling of coal dust silos
- the extraction and transport of wood dust in filter and ventilation systems
- the handling and storage of grain
- grinding, mixing and mechanical conveyance of organic products such as grain, feed, sugar, plastics, dyestuffs and pharmaceuticals
- spray drying of organic products, e.g. milk, coffee, detergent
- drying, granulation and coating in fluid bed equipment
- the grinding of light metals and their alloys
- the manufacture and processing of metal powders

The selection and specification of appropriate prevention and/or constructional protection measures with respect to safety, ecology in a cost-effective manner requires detailed

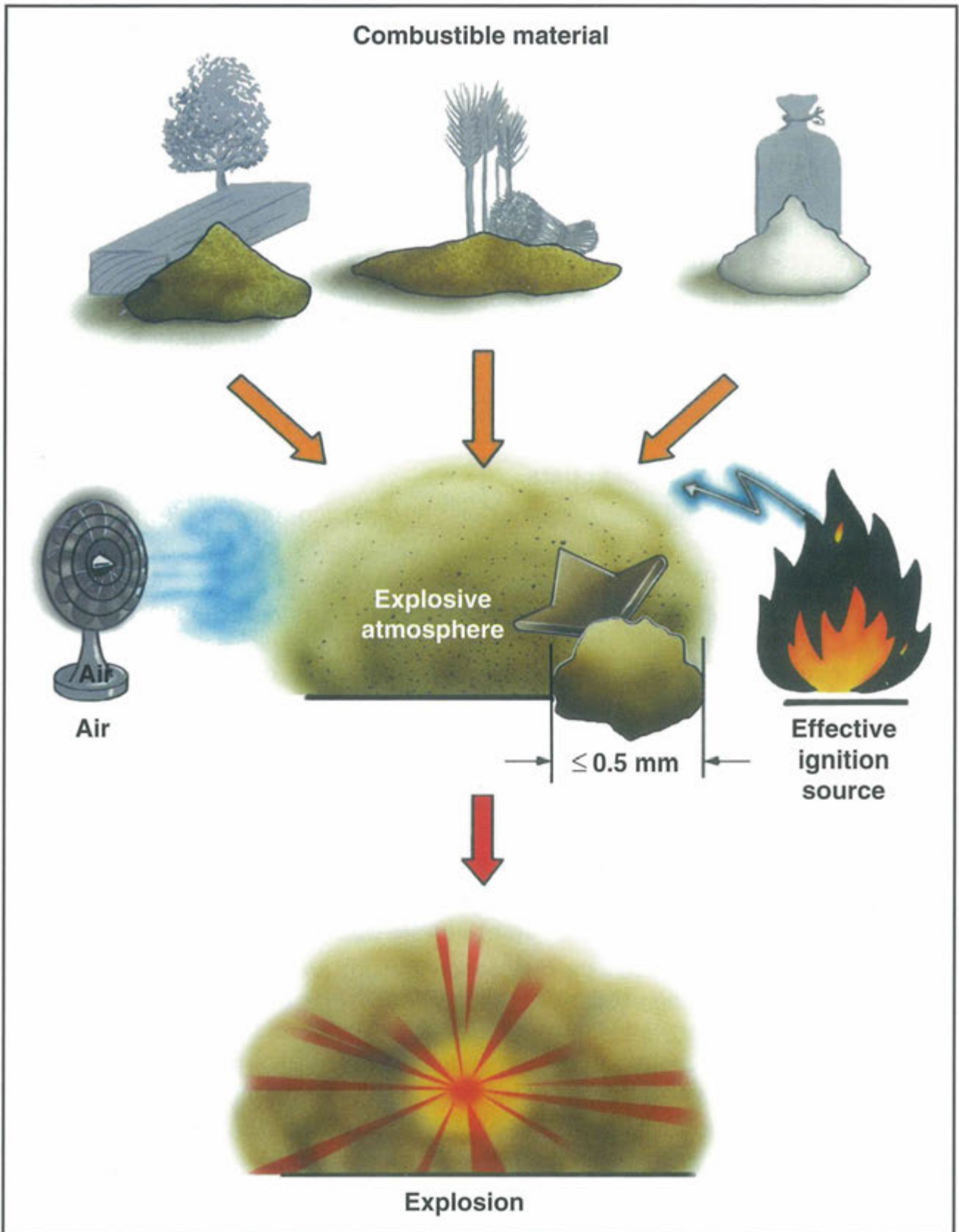

Fig. 1: Prerequisites for the occurrence of explosions

knowledge of the causes and development of fires¹⁾ and explosions as well as the effectiveness of prevention and protection measures [1]²⁾, [2]²⁾, [3] - [25].

¹⁾ The remaining sections of this brochure deal only with the area of explosion prevention and protection.

²⁾ Since the legal regulations regarding explosion protection differ from country to country, e.g. in Europe with regard to the approval procedures for apparatuses and protection systems [1], [2], these formal aspects are not given further consideration in the brochure.

2 Explosion prevention

The principle of explosion prevention is to avoid (eliminate) at least one of the prerequisites for the occurrence of an explosion. There are three basic ways of doing this:

- avoiding explosive dust/air mixtures by eliminating and/or reducing combustible dusts
- avoiding explosive dust/air mixtures by eliminating and/or reducing the oxygen required for combustion
- avoiding effective ignition sources

2.1 Avoiding explosive dust/air mixtures

2.1.1 Eliminating combustible dusts

Explosions can be avoided when handling dusts by replacing combustible materials with non-combustible materials, or by adding sufficient quantities of non-combustible material to the combustible substances.

If the particle size is sufficiently large - e.g. greater than 0.5 mm - the danger of explosion is reduced or even eliminated. However, even with coarse particles it must be borne in mind that mechanical processing of the material, for example, can also create fine dust.

The occurrence of explosive dust/air mixtures, or dust deposits, in the vicinity of powder handling equipment, can be avoided by leak free construction or dust extraction measures. In practice, however, dust deposits frequently cannot be avoided, and for this reason regular cleaning to remove dust deposits becomes extremely important. Elimination of dust from the inside of powder handling equipment is rarely possible, but in some cases combustible filling materials can be replaced by non-combustible materials.

2.1.2 Limiting the concentration of combustible dusts

Dust explosions are prevented if the dust concentrations are kept outside the explosion limits. This measure can be used on its own or in addition to other methods, depending on the process technology and the characteristic properties of the dust.

For example, simply dividing the total amount of dust by the total volume of the vessel does not provide an accurate value of the concentration at any particular point in the vessel volume owing to the inhomogeneity of the dust distribution.

In view of the interchange between deposited and airborne dust, the explosion limits for combustible dusts do not have the same significance as those for flammable gases and vapours. The dust concentration changes constantly due to dust being deposited on the one hand and being dispersed into the air on the other, making it extremely difficult to maintain safe conditions.

In the vicinity of powder handling equipment it is especially important to limit the quantity of combustible material and thereby reduce the probability that explosive dust/air mixtures could occur.

The escape of dust into the surroundings (work areas) must be limited (prevented) by leak free construction and dust removal measures (low pressures, dust extraction or vacuum-cleaning of objects). Unavoidable dust deposits must be removed by regular cleaning.

Explosion prevention measures also include the use of wet scrubbers. These mix water with the dust so intensively that it becomes a moist sludge and in this condition can no longer create explosive dust/air mixtures.

In special cases, limitation of the dust concentration is a possible protective measure when a dust concentration well below the lower explosion limit of the fine dust can be guaranteed in a plant or plant units.

In the inside of the ducts of room air extraction systems and the ducts after filter installations, the lower explosion limit is not reached in normal operation. Deposition of the dust over a period of time must however be taken into account. These dust deposits can become dispersed and hence constitute an explosion hazard. Regular cleaning can be employed to remove the hazard.

As a rule, the high product loading in dense-flow pneumatic powder conveying systems causes the upper explosion limit to be exceeded. However, explosive dust mixtures can arise on startup and shutdown as well as at the product stream inlet into a filter, cyclone, or silo.

Above all, if the concentration can be displaced into the explosion range during startup and shutdown phases, additional preventive measures, e.g. inerting during these operations may be necessary under certain circumstances.

An appropriate measure to prevent the formation of explosive concentrations involves binding of the fine dust by spraying with liquids e.g. water or special oils.

2.2 Limiting the oxygen concentration

2.2.1 Inerting with gases

Inerting can be used as a preventive measure to avoid dust explosions [9], [10]. It prevents the occurrence of explosions by the replacement of the atmospheric oxygen - at least in part - by an inert gas - usually nitrogen or carbon dioxide. The use of this particular measure requires specialized knowledge and a thorough understanding of the inerting process, and presupposes a gas-tight system.

The limiting oxygen concentration in a dust/air/inert gas mixture is determined experimentally by variation of the dust concentration and the oxygen concentration until a dust explosion is just prevented. It is a value specific to the dust (see Table 1) and the inert gas. For example, when carbon dioxide is employed as inert gas, higher values of the limiting oxygen concentration are found than in the case of nitrogen.

If systems operate at elevated temperatures, it should be borne in mind that the limiting oxygen concentration falls with increasing temperature (approx. 1.5 vol. % per 100° C temperature increase).

Dust type	Median value (M) [μm]	Limiting oxygen concentration (LOC) [vol. %]
Pea flour	25	15.5
Cadmium laureate	< 63	14
Hard (fat) coal	17	14
Barium stearate	< 63	13
Rye flour	29	13
Lignite	63	12
Carbon black	13	12
Organic pigment	< 10	12
Herbicide	10	12
Cadmium stearate	< 63	12
Calcium stearate	< 63	12
Wheat flour	60	11
Polyacrylonitrile	26	11
Cellulose	22	10.5
Wood	27	10
Resin	63	10
Methyl cellulose	70	10
Polyethylene (HDPE)	26	10
β -naphthol	< 30	9.5
Bisphenol A	34	9.5
Corn flour	17	9
Wettable sulfur with 20 % lignin sulfonate	30	7
Paraformaldehyde	23	6
Aluminium	22	5

Table 1: Limiting oxygen concentration (LOC) in nitrogen
(1 m³ vessel, ISO method)

In general, the highest permissible oxygen concentration for use under practical conditions should be 2 vol. % below the experimentally determined limiting oxygen concentration.

The inerting must be monitored to ensure that the highest permissible oxygen concentration is not exceeded. This can be effected by continuous or intermittent measurement. Particular attention should be paid to the following:

- selection of a suitable measurement parameter (e.g. oxygen concentration)
- selection of a suitable measurement technique (e.g. measurement principle, transverse sensitivity, limits of error, time constant of the measuring instrument, time delay of the display due to the separation between measuring instrument and sampling site)
- selection of a suitable measurement position where, with due consideration being given to the flow situation, the most adverse conditions for the oxygen concentration can be detected. If necessary, several measuring positions can be used.

When intermittent measurements are used to monitor the oxygen concentration, it should also be ensured that:

- completely self-contained systems with continuously defined and reproducible gas flow direction are present (hazard: cleaning hatches)
- safe operating conditions for inerting have been defined beforehand from trials over a sufficiently long period of operation
- the operating conditions are checked and redefined if necessary after every change in the system
- the extent of inerting the plant units in question is known for all operational conditions

and

- any interruption of the flow of inerting gas is notified by an alarm and further measures are initiated immediately

Suitable measures must be established in case of operational malfunction:

- shutdown of the plant when the maximum permissible oxygen concentration is exceeded or the gas concentration required for perfect inerting is not attained (shutdown should normally be automatic)
- selection of a suitable alarm threshold above which countermeasures are triggered (automatically/manually)

With the inerting described here dust fires cannot be ruled out: this requires much lower oxygen concentrations. Inerting is not an effective preventive measure against thermal decomposition (spontaneous decomposition) which can proceed in the absence of atmospheric oxygen.

The suitability of the inert gas must always be checked. Light metal dusts can react with carbon dioxide, for example, and in some cases also with nitrogen.

With hybrid mixtures of combustible dust and flammable gases or vapors, the maximum permissible oxygen concentration is determined using the flammable material with the lowest limiting oxygen concentration value (Figures 2 and 3).

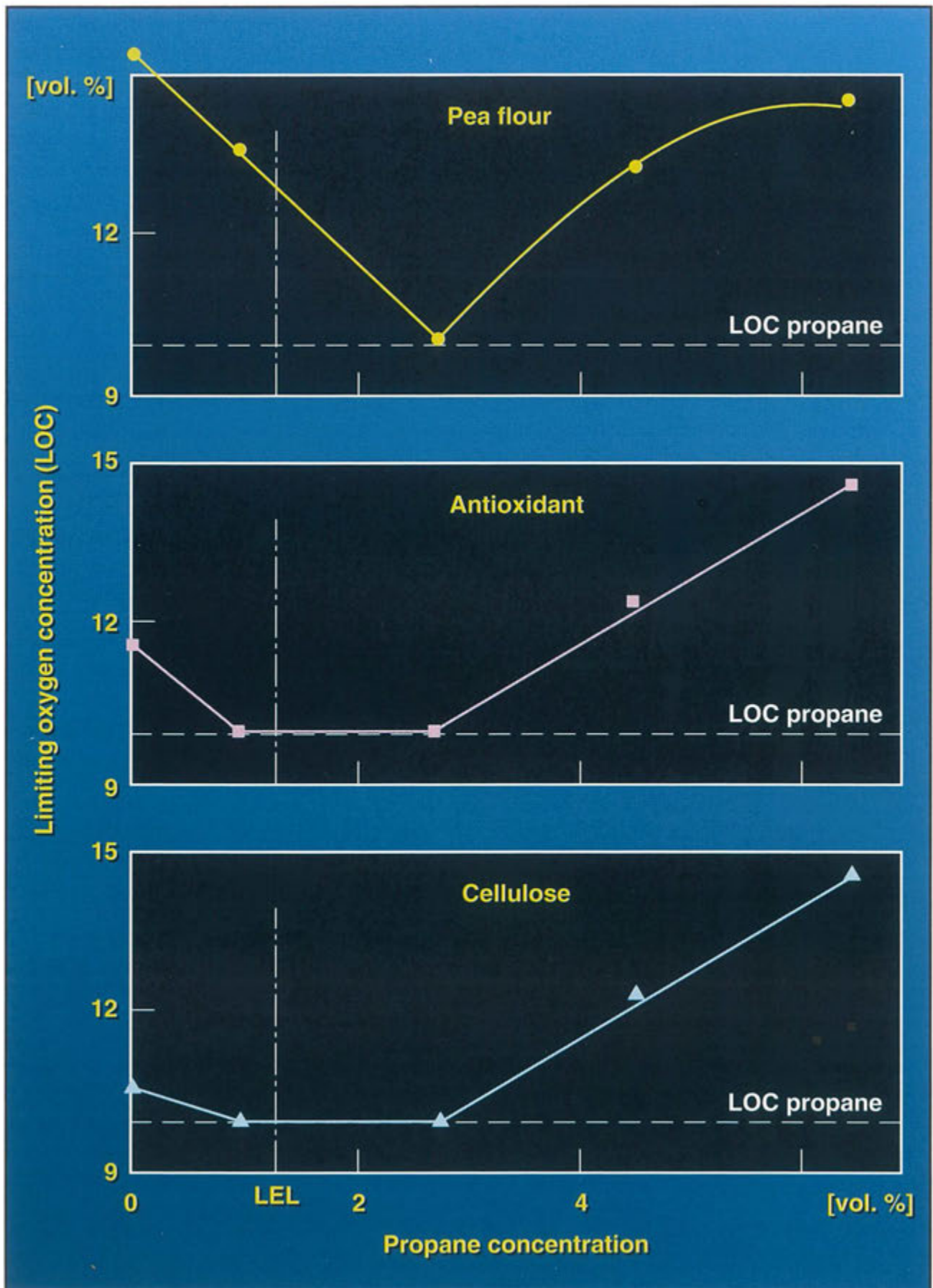

Fig. 2: Inerting of hybrid mixtures with nitrogen: combustible dusts/propane (1 m³ vessel, ISO method)

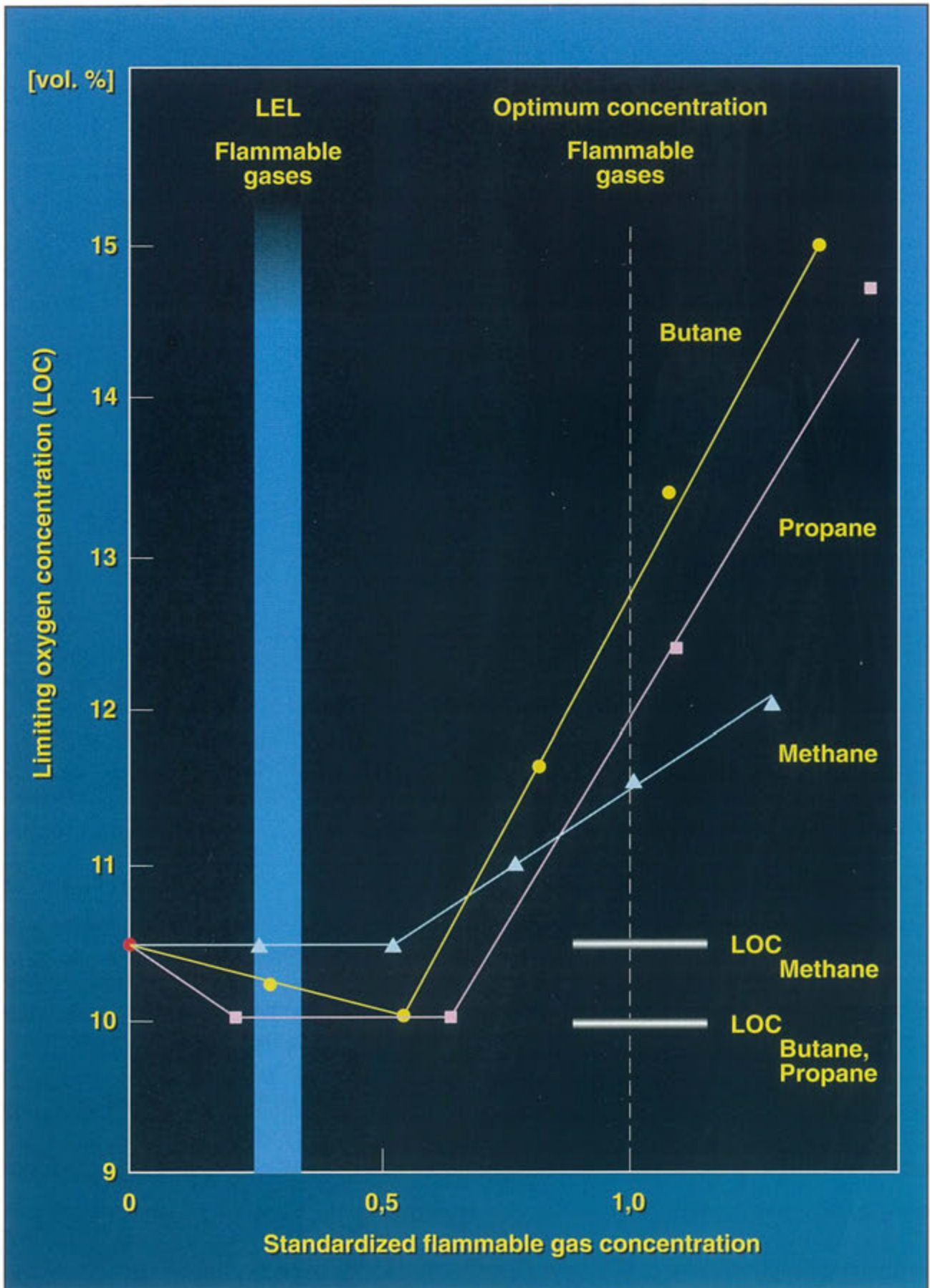

Fig. 3: Inerting of hybrid mixtures with nitrogen: cellulose/flammable gases (1 m³ vessel, ISO method)

In Figures 2 and 3 the values for the limiting oxygen concentration of the gases are lower than the values stated in the literature (approx. 2 vol. %), which is due to the boundary conditions specified for the dust testing procedure in 1 m³ vessels (ignition energy of 10 kJ, turbulent mixture).

2.2.2 Inerting with solids

Combustible dusts can be converted into mixtures no longer capable of propagating an explosion by addition of non-combustible solids (e.g. rock salt, sodium sulfate, or phosphates). Generally speaking, the proportion of inert solids must be greater than 50 wt % (Table 2).

Combustible dust	Median value (M) [μm]	Non-combustible solid	Median value (M) [μm]	Minimum proportion of non-combustible solid [wt %]
Methyl cellulose	70	CaSO ₄	< 15	70
Organic pigment	< 10	NH ₄ H ₂ PO ₄	29	65
Hard (fat) coal	20	CaCO ₃	14	65
Hard (fat) coal	20	NaHCO ₃	35	65
Sugar	30	NaHCO ₃	35	50

Table 2: Avoiding of explosive dust/air mixtures by admixture of non-combustible solids (1 m³ vessel, ISO method)

2.2.3 Use of vacuum

A reduction in the pressure to below atmospheric pressure can either prevent the occurrence of an explosion (this is generally the case for dust/air mixtures with the initial pressures of approx. 50 mbar) or keep the explosion pressure below the atmospheric pressure. Since the explosion pressure is dependent on the initial pressure, this situation is found for dusts with a maximum excess explosion pressure of 10 bar if the initial pressure is less than 0.1 bar (Fig. 4). Furthermore, as the pressure falls, the minimum ignition energy increases. The higher the vacuum, the higher the safety level.

The vacuum must be monitored by measurement and if a malfunction occurs (e.g. ingress of air) this must be prevented by filling with inert gas.

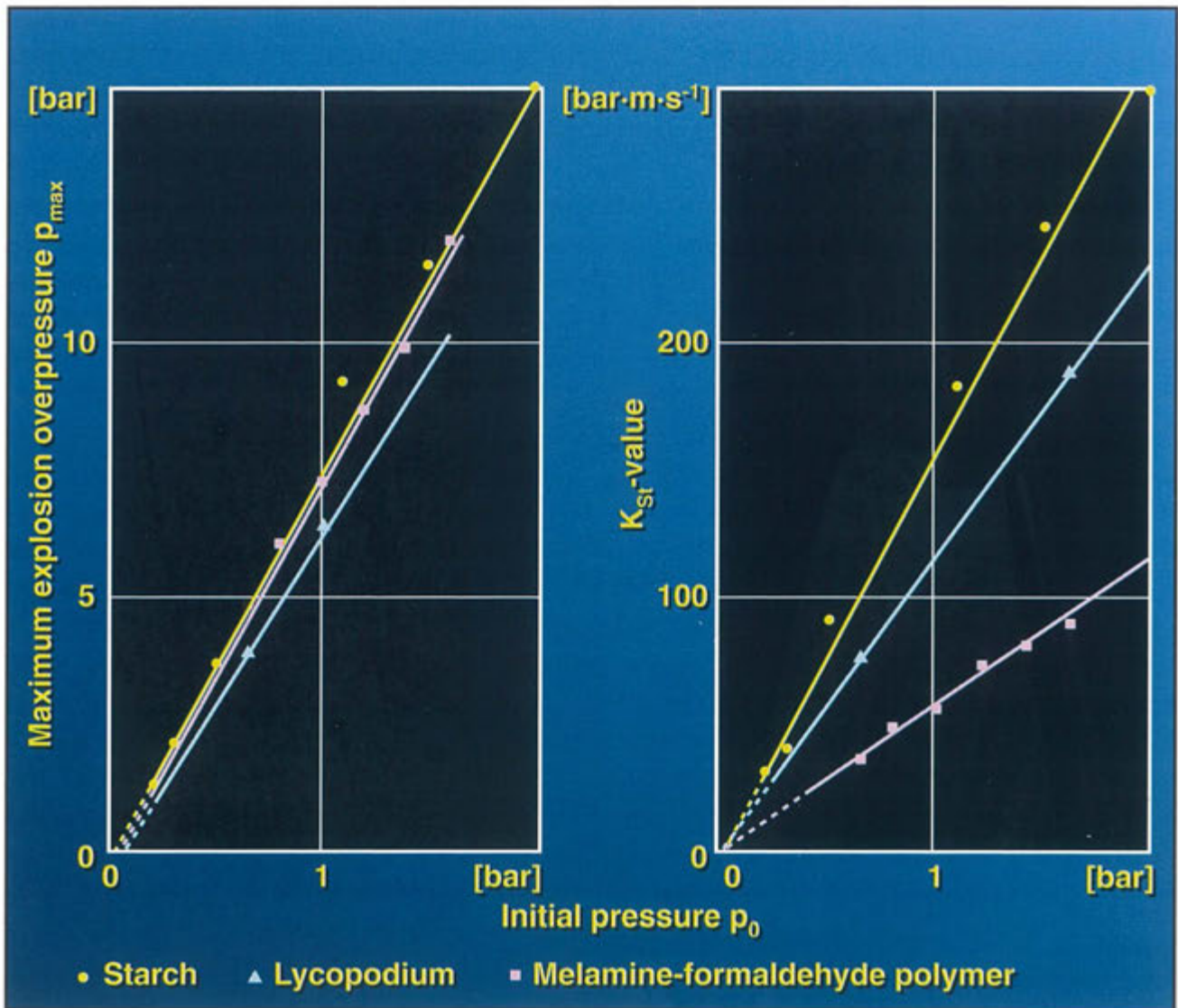

Fig. 4: Influence of the initial pressure on the explosion characteristics

2.3 Avoiding effective ignition sources

Dust explosions can be prevented if ignition sources which, owing to their properties, (e.g. energy, temperature, lifetime) are capable of igniting dust/air mixtures, can be eliminated.

In this connection, a distinction must be made between:

- commonplace ignition sources (e.g. welding, grinding, smoking)
- ignition sources that result from normal operations (e.g. hot surfaces, electrical or electrostatic sparks)

and

- ignition sources expected in the plant if malfunctions or mishaps occur (e.g. tramp material in mills, lumps of smoldering material)

If the first can be excluded by organizational measures (e.g. written definitions of codes of behavior and safety measures) and if operational ignition sources and sources resulting from malfunction can be excluded with certainty (e.g. protection of electrical installations against dust explosion, perfect electrostatic grounding, no high-speed or high-performance mechanical drives, tramp material in mills, lumps of smoldering material), these preventive measures may be regarded as adequate according to the present state of knowledge. Particular care is needed in the application of this type of preventive measure in the case of dusts with a low minimum ignition energy (< 10 mJ) and for hybrid mixtures - i.e. mixtures of combustible dust and flammable gases or vapors. In these cases, the elimination of ignition sources by itself may be inadequate. The following important ignition sources (Fig. 5) for dust/air mixtures require particular attention:

- hot surfaces
 - flames and hot gases
 - grinding, friction and impacts which can cause sparks and hot surfaces
 - electrical equipment (plant) with no facilities for prevention against dust explosions
 - static electricity (especially spark discharges, propagating brush discharges and cone discharges) [11] - [13]
- and
- strongly exothermic chemical reactions

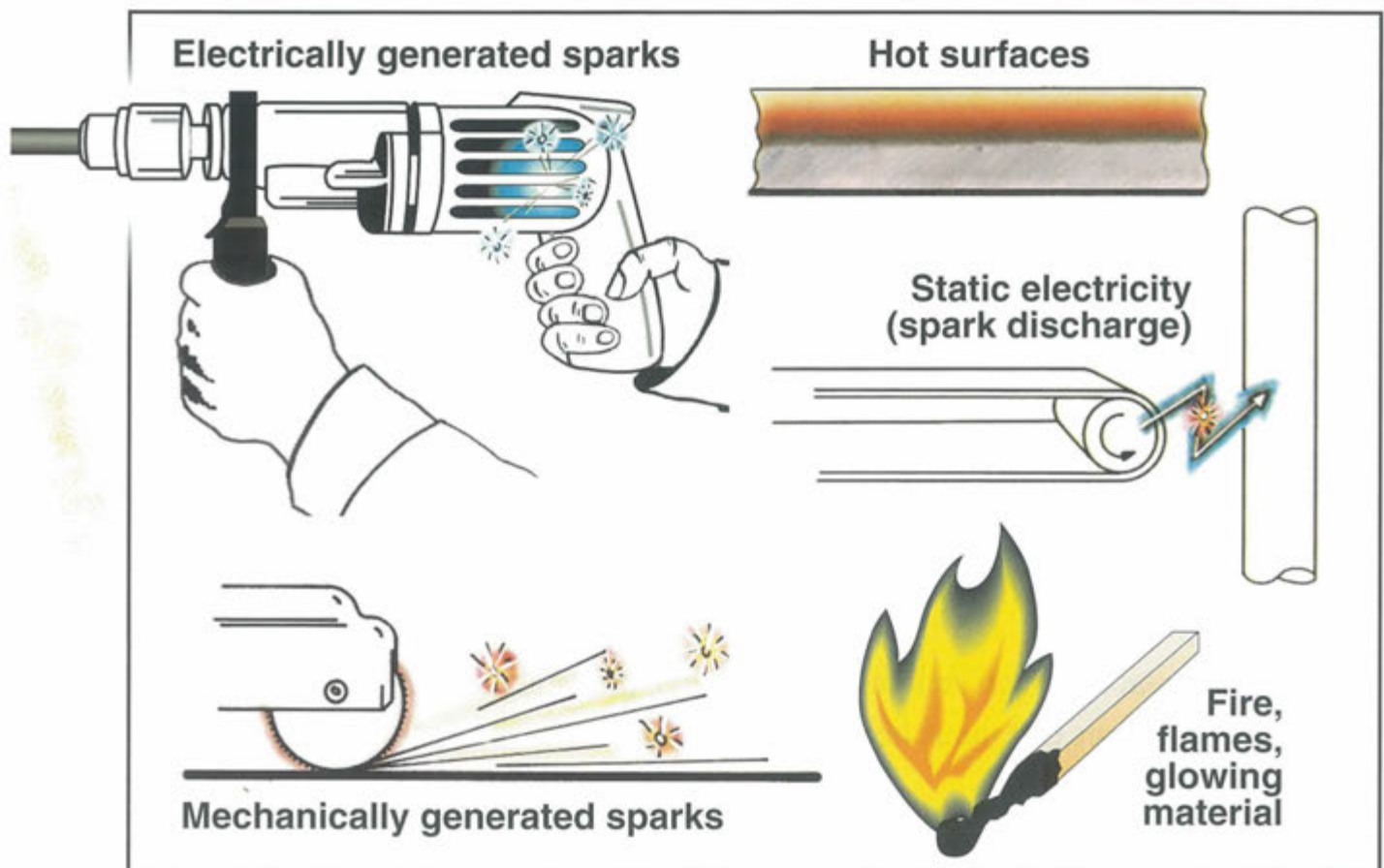

Fig. 5: Examples of possible ignition sources

In connection with the ignition effectiveness of mechanically generated sparks in dust/air mixtures, analysis of incidents has led to the following values for the relationship between the ignition ability of rotating parts and their relative speed v :

$v \leq 1 \text{ m} \cdot \text{s}^{-1}$	no ignition hazard
$1 \text{ m} \cdot \text{s}^{-1} < v \leq 10 \text{ m} \cdot \text{s}^{-1}$	each case must be considered on its own merits taking into account data for the specific dust and construction material
$v > 10 \text{ m} \cdot \text{s}^{-1}$	an ignition hazard exists in all cases

The assumption that no additional ignition hazard exists at very low relative speeds was confirmed by the results of investigations. Figure 6 shows the relationship between the contact force F_A and the relative speed v during grinding and rubbing of steel pins on steel discs. At relative speeds of $\leq 1 \text{ m} \cdot \text{s}^{-1}$, and under these testing conditions, neither the formation of grinding or friction sparks nor the appearance of hot surfaces are likely to occur.

To facilitate a comparison of the ignition abilities of mechanically generated sparks with one another and with the minimum ignition energy of dusts, an equivalent electrical energy E_Q is assigned to them. This is the energy of a capacitor discharge which has the same ignition effectiveness as a theoretical mechanical spark. Figures 7 and 8 show the relationship between the equivalent electrical energy E_Q for grinding and impact sparks which arise from short-term contact of the materials (20 ms to 50 ms) and the minimum ignition temperature of a dust cloud MIT_C of the combustible materials. So-called ignition limit lines result for the different materials.

Knowledge of the minimum ignition temperature of a dust cloud MIT_C and the minimum ignition energy MIE is thus required for assessment of the ignition capability of mechanical sparks. The relevant equivalent electrical energy can be determined from Figures 7 and 8 with the aid of the minimum ignition temperature of a dust cloud and the ignition limit line of the material in question. Ignition of a dust cloud is possible if the minimum ignition energy of the dust lies below the equivalent electrical energy.

As Figures 7 and 8 also show, sparks of mechanical origin can ignite dusts with a low minimum ignition temperature of a dust cloud (e.g. $MIT_C = 300^\circ \text{C}$) even if they have a high minimum ignition energy. If, on the other hand, the dusts possess a high minimum ignition temperature (e.g. $MIT_C = 600^\circ \text{C}$) they can be ignited only if they have a very low minimum ignition energy.

The ignition effectiveness of mechanically generated sparks decreases in the following order (Figures 7 and 8):

- lighter flint friction and grinding sparks
- zirconium grinding sparks
- titanium grinding and titanium/rust impact sparks
- steel grinding sparks

and

- aluminum/rust impact sparks

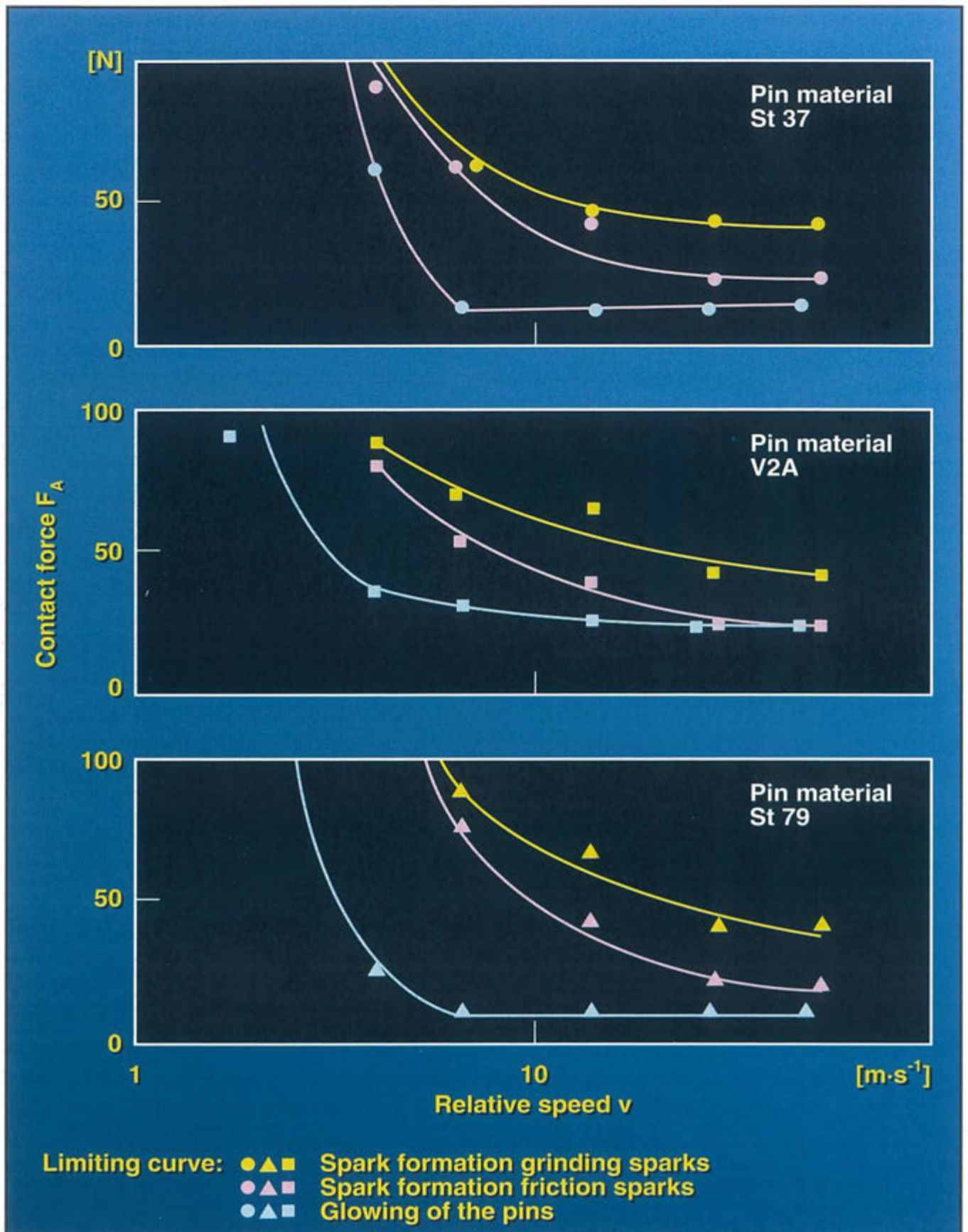

Fig. 6: Limiting curves for the formation of grinding and friction sparks as well as hot surfaces
 Disk materials correspond to the pin materials - pin diameter: 4 mm

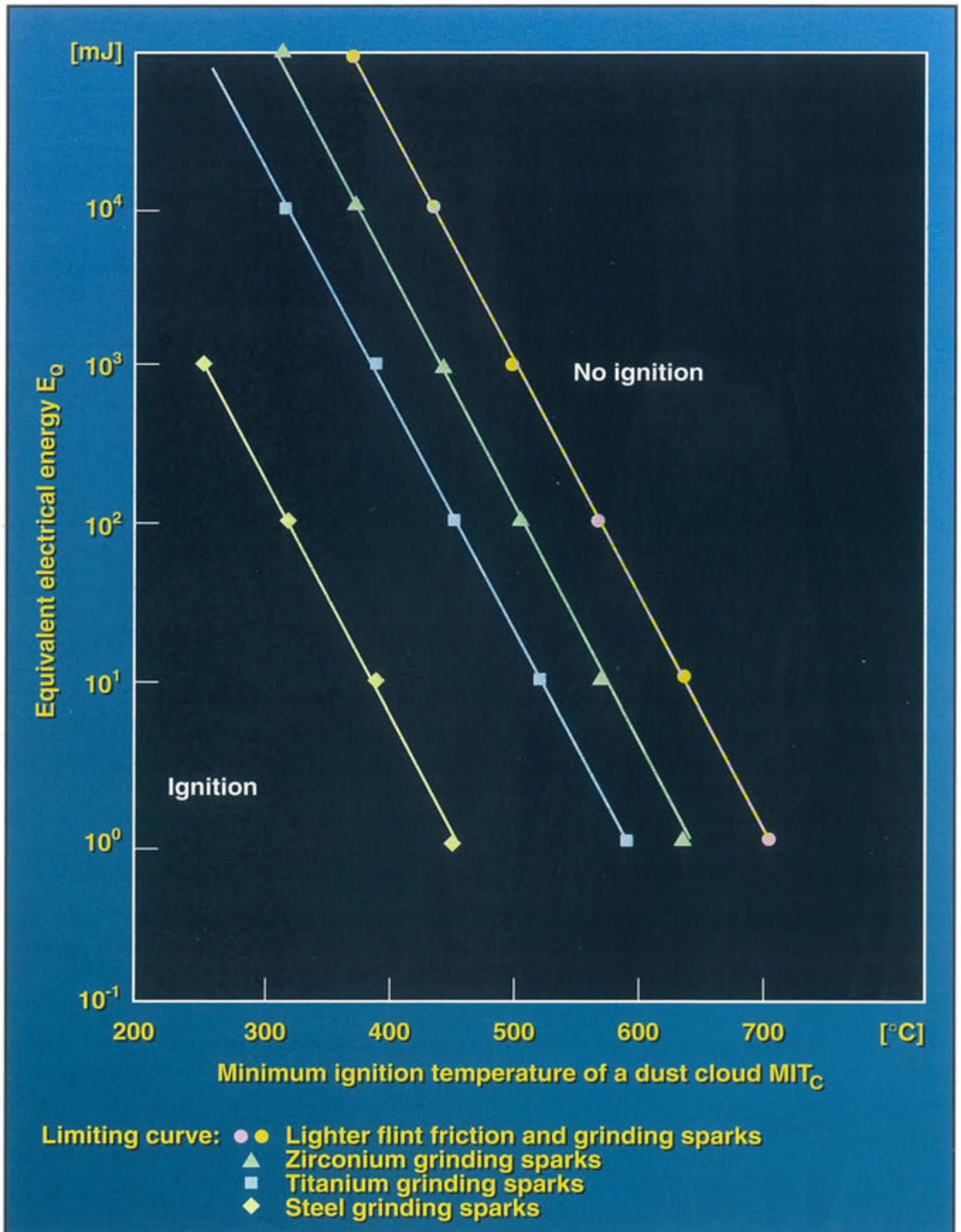

Fig. 7: Grinding sparks: relationship between equivalent electrical energy E_Q and minimum ignition temperature of a dust cloud MIT_C
 $F_A = 60 \text{ N}$, $v = 30 \text{ m} \cdot \text{s}^{-1}$

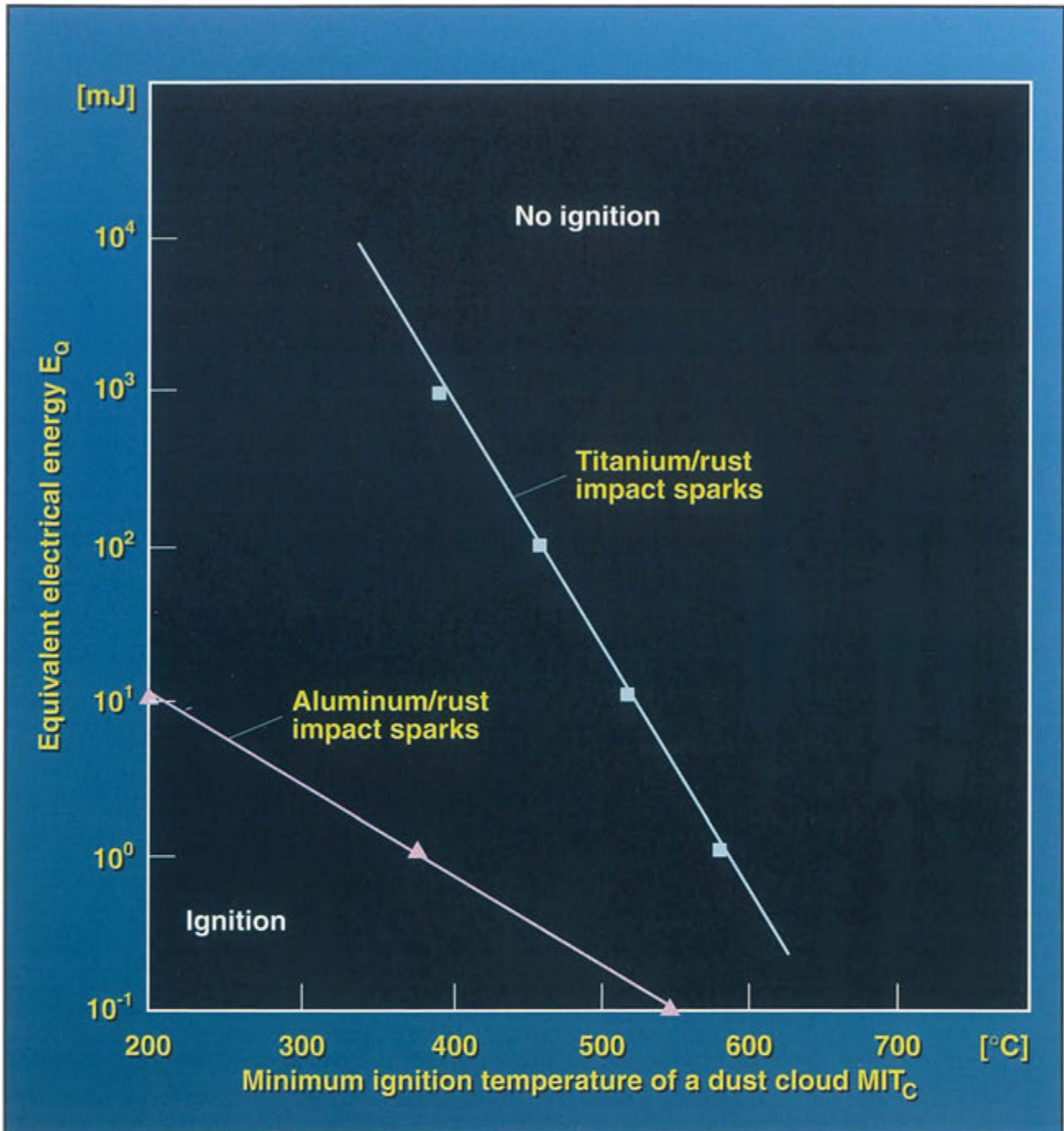

Fig. 8: Impact sparks: relationship between equivalent electrical energy E_Q and minimum ignition temperature of a dust cloud MIT_C
 $F_A = 60 - 100 \text{ N}$, $v = 25 \text{ m}\cdot\text{s}^{-1}$

Of the examples listed, steel grinding sparks have a very poor ignition effectiveness (Fig. 9). With a typical minimum ignition temperature of a dust cloud of, for example, $MIT_C = 400^\circ \text{ C}$, only dust/air mixtures which have a minimum ignition energy of $< 10 \text{ mJ}$ are ignited. The friction sparks which appear when steel is rubbed against steel for a relatively long time (0.5 s - 2 s) are more effective igniters. For the same minimum ignition temperature of a dust cloud ($MIT_C = 400^\circ \text{ C}$), ignition of dust/air mixtures must be expected when their minimum ignition energy is below 100 mJ.

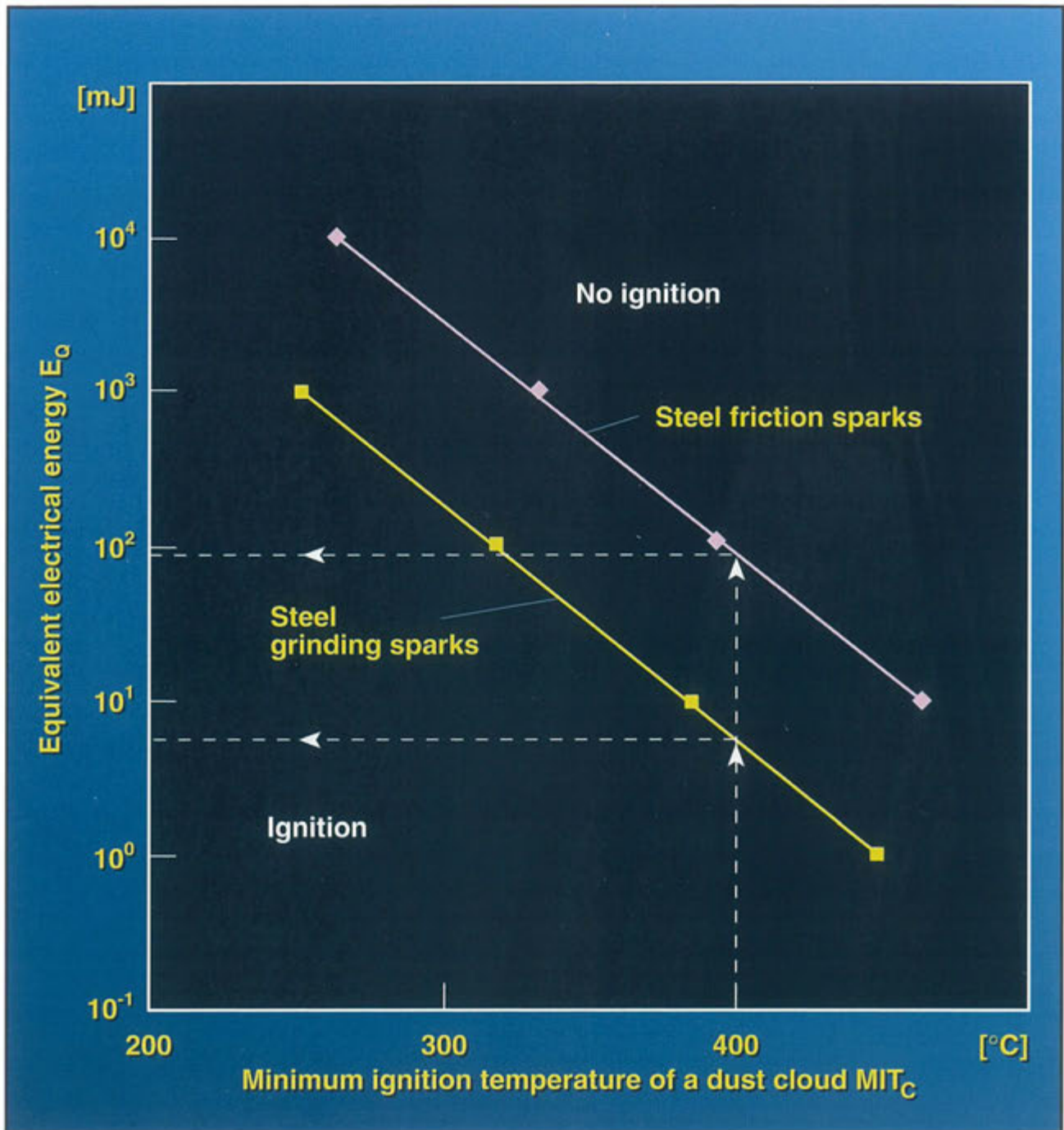

Fig. 9: Steel grinding and friction sparks: relationship between equivalent electrical energy E_0 and minimum ignition temperature of a dust cloud MIT_C
 $F_A = 60 - 90 \text{ N}$, $v = 25 \text{ m}\cdot\text{s}^{-1}$

In summary, it can be seen that the minimum ignition temperature of a dust cloud, the minimum ignition energy and the type of material giving rise to sparks are important factors determining the likely ignition of dust/air mixtures by mechanically generated sparks (grinding, friction, and impact sparks).

According to the present level of knowledge, it appears that many dusts can be ignited by capacitor discharges just as easily as the flammable gases methane, butane, propane, and propylene. These are dusts with a minimum ignition energy of $< 10 \text{ mJ}$ (Fig. 10).

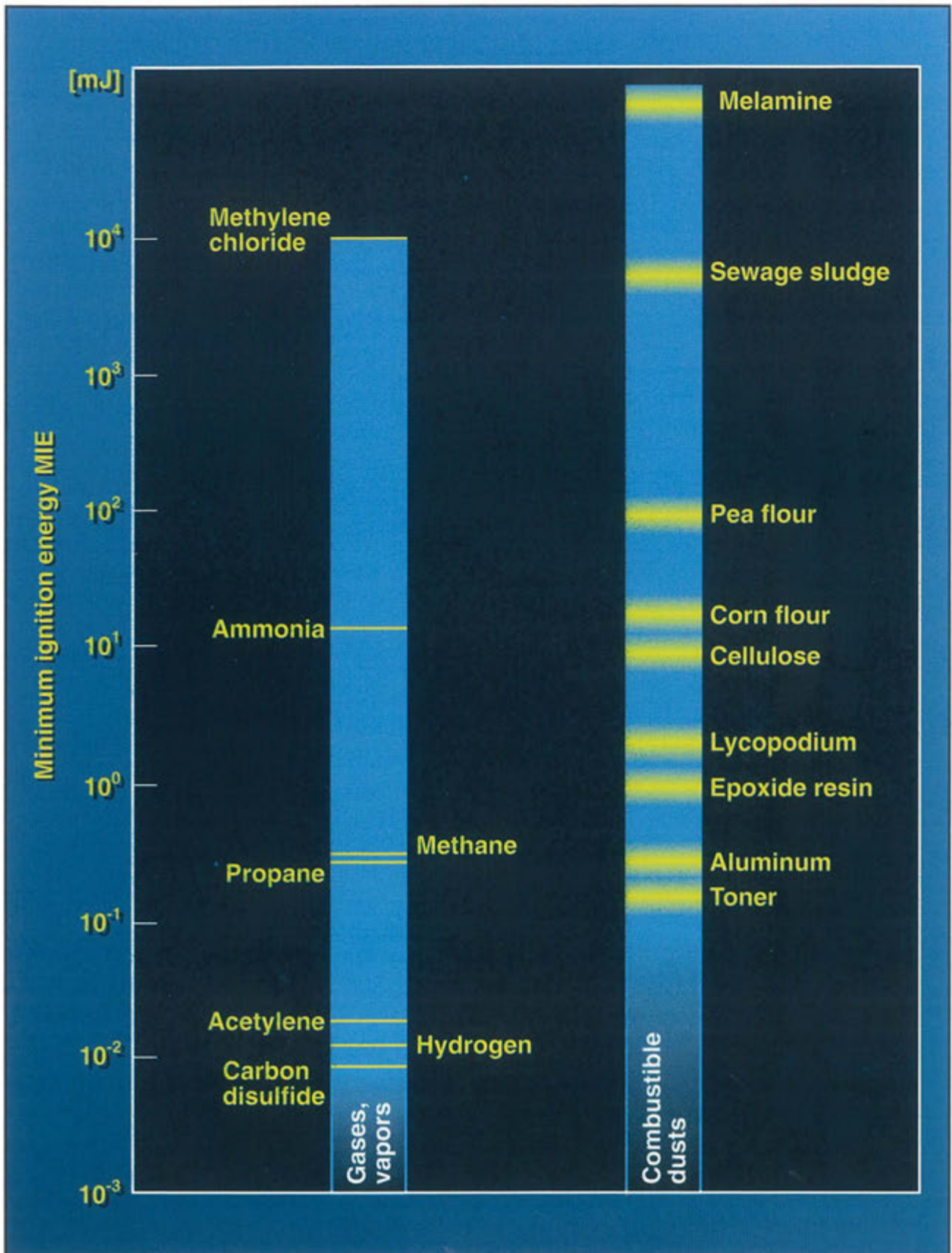

Fig. 10; Minimum ignition energy: comparison between flammable gases and combustible dusts (The minimum ignition energies of the above dusts depend on the condition of the dust - e.g. particle size, moisture - and may differ considerably from the values shown)

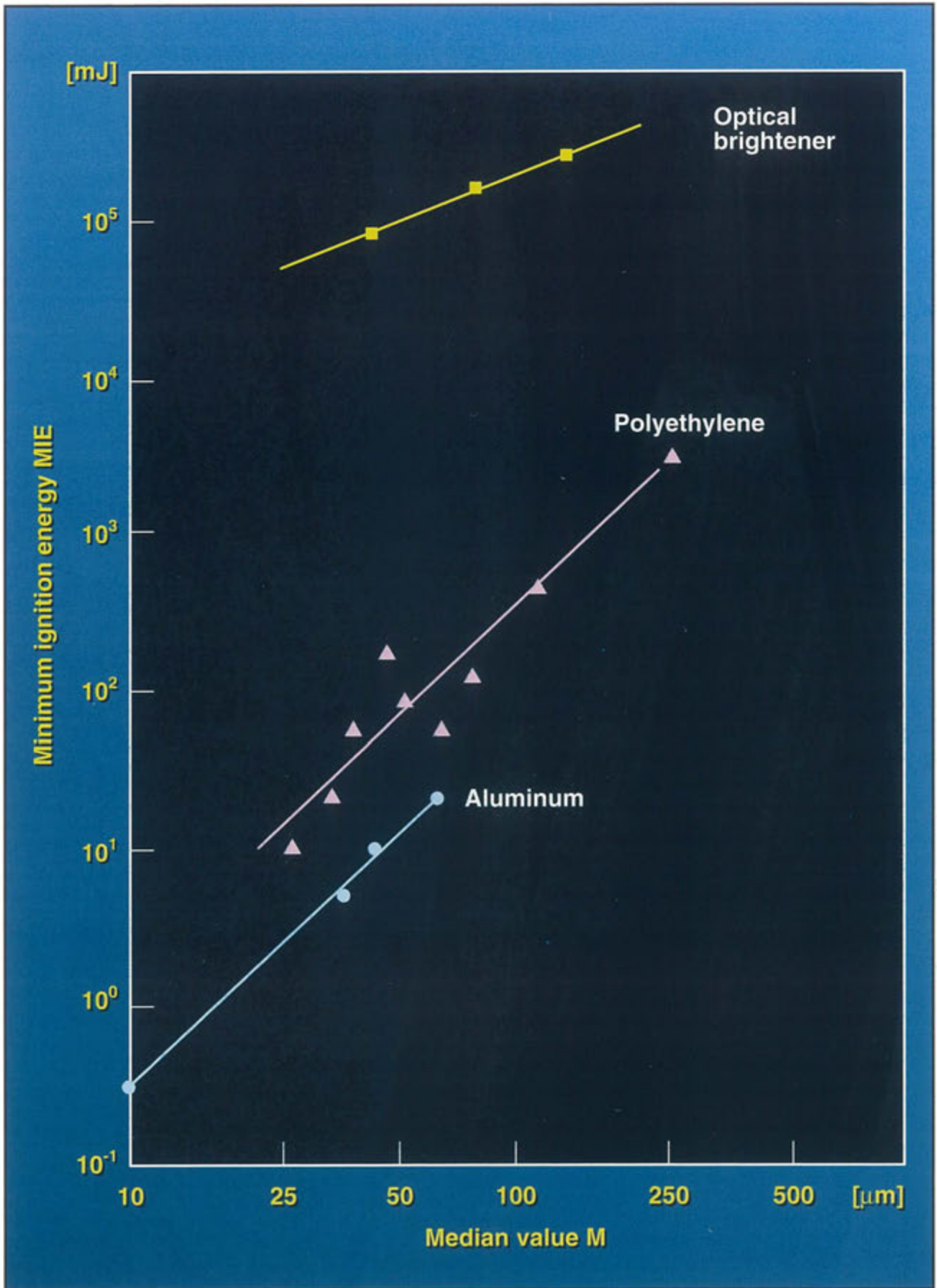

Fig. 11: Combustible dusts: relationship between median value and minimum ignition energy

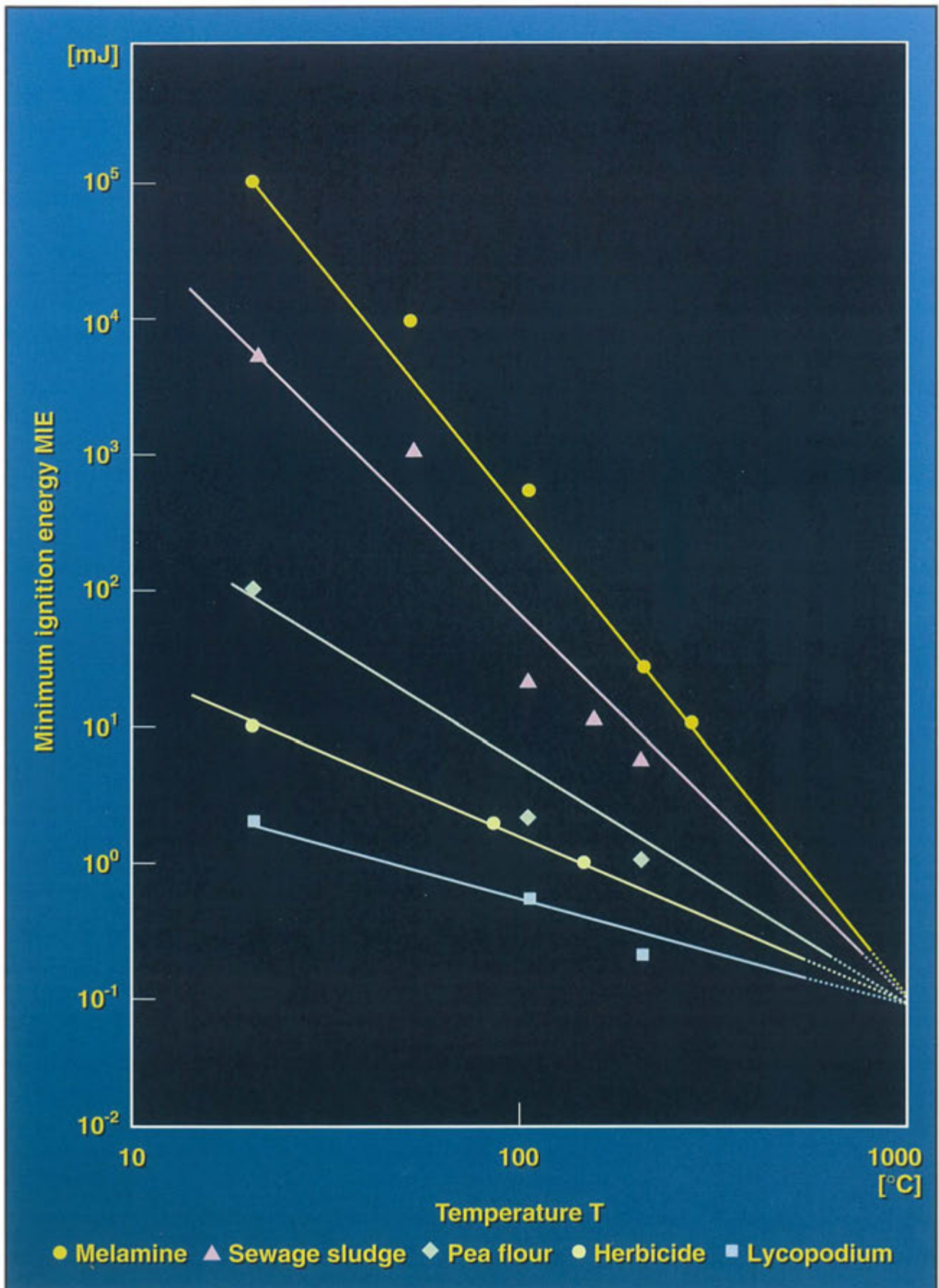

Fig. 12: Influence of the temperature on the minimum ignition energy of combustible dusts

The minimum ignition energy is influenced considerably by the particle size or particle size distribution - approximated by the median value (Fig. 11) - by the temperature (Fig. 12) and the moisture (H_2O) content of the product (Fig. 13). The protracted capacitor discharge used in these tests to determine the minimum ignition energy is a more effective ignition source than a purely capacitive discharge. However, there are dusts which ignite just as easily with a purely capacitive discharge.

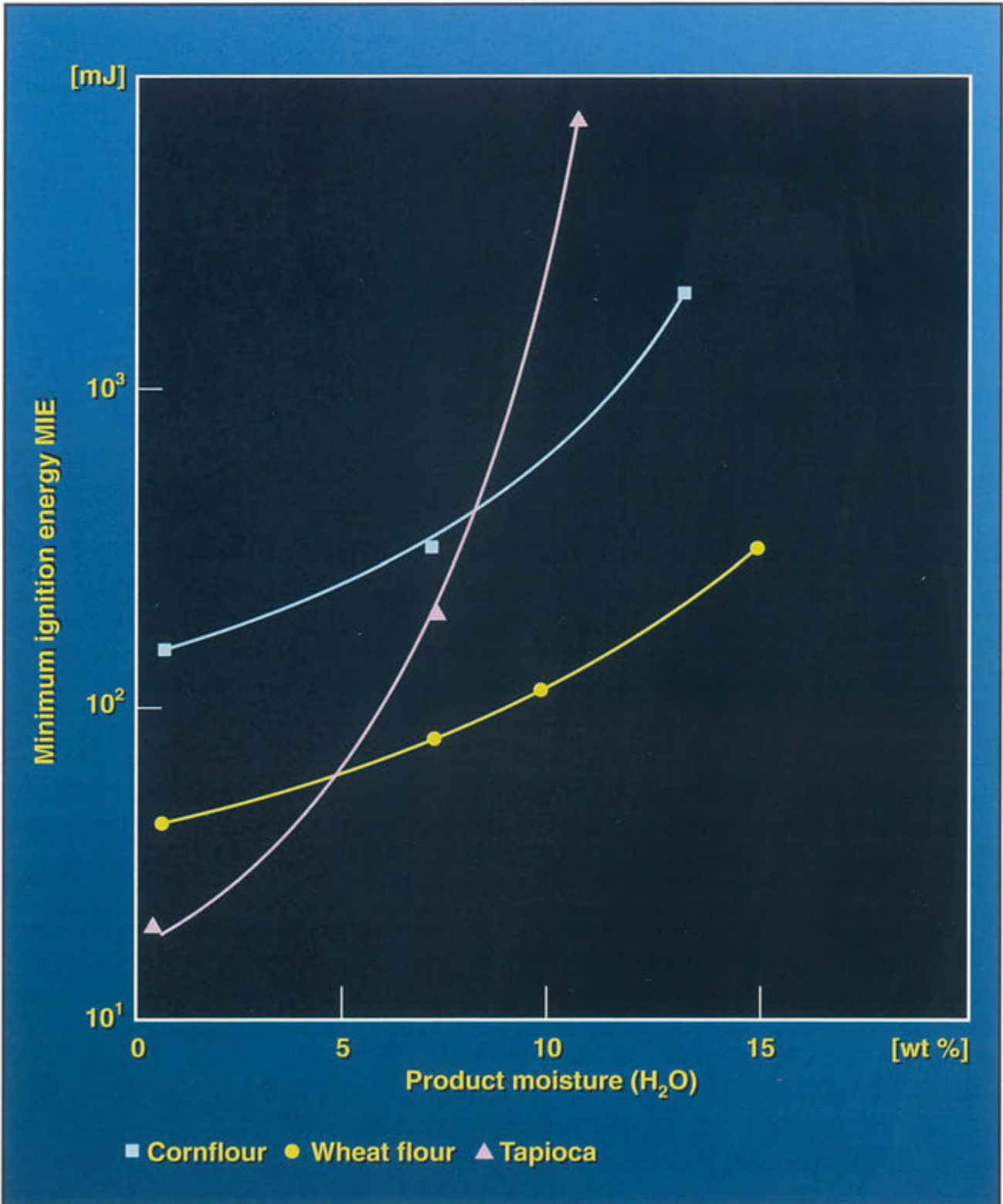

Fig. 13: Influence of the product moisture (H_2O) on the minimum ignition energy

Further, it has been shown that several dusts can be ignited at a minimum ignition energy below 3 mJ. As a consequence, ignition by brush discharges cannot be completely ruled out for such dusts (Table 3).

Considering the different types of electrostatic discharge (Fig. 14.1 to 14.5) [13], it is clear that:

- the hazards associated with electrostatic spark discharges should be assessed by comparison with the ignition energy determined using purely capacitor discharge
- propagating brush discharges can cause ignition in situations where the dust has a minimum ignition energy of up to 1 J
- cone discharges must also be taken into consideration when highly insulating coarse material (volume resistivity $> 10^{10} \Omega \cdot m$) is handled together with fine material

The avoiding of effective ignition sources can be assessed only when the appropriate safety characteristics of the combustible dusts are known; of particular significance are the minimum ignition energy and the minimum ignition temperature of the dust cloud.

Type of discharge	Effectiveness as ignition source for mixtures with air of:		
	hydrogen, acetylene, etc. MIE ≤ 0.025 mJ	solvent vapors MIE > 0.025 mJ	dry, combustible dusts MIE > 1 mJ
Spark	+	+	+
Brush	+	+	(-) ¹⁾
Propagating brush	+	+	+
Corona	(+)	-	-
Cone	+	+	+

¹⁾ Ignition of dusts **highly sensitive** to ignition cannot be completely ruled out.

Table 3: Incendivity of various types of electrostatic discharge [13]

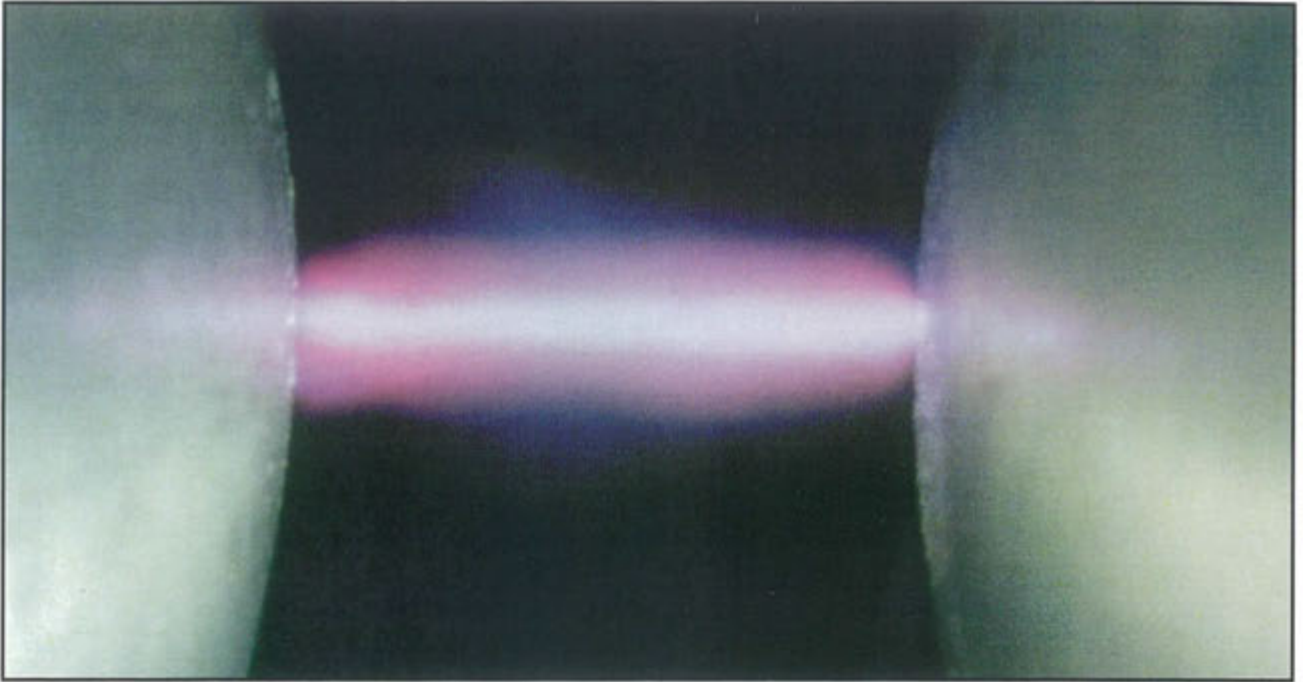

Fig. 14.1: Spark discharge (photo)

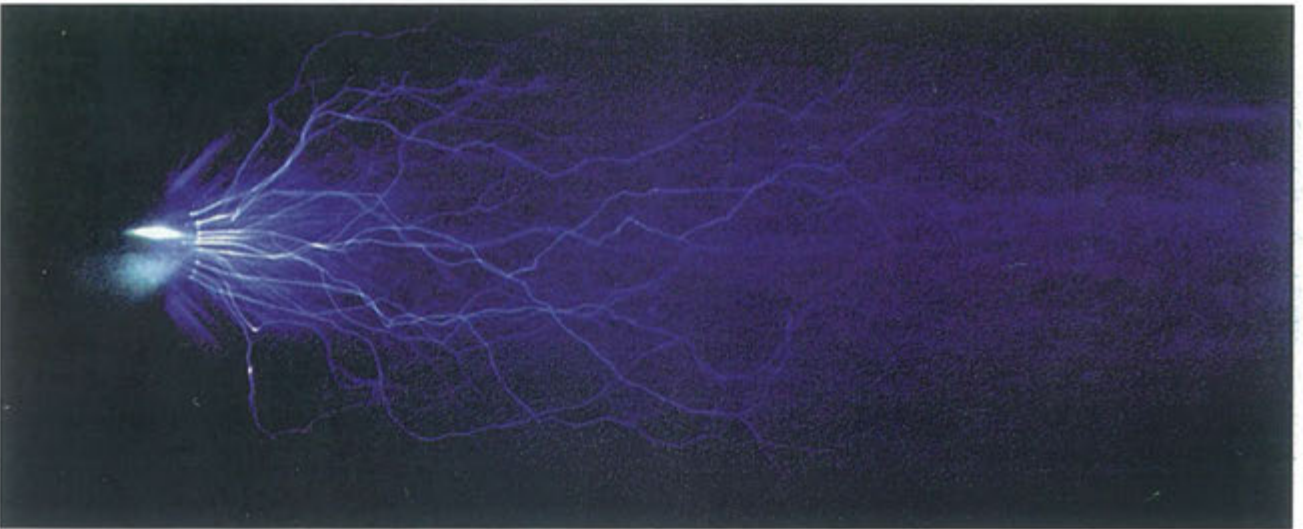

Fig. 14.2: Brush discharge (photo)

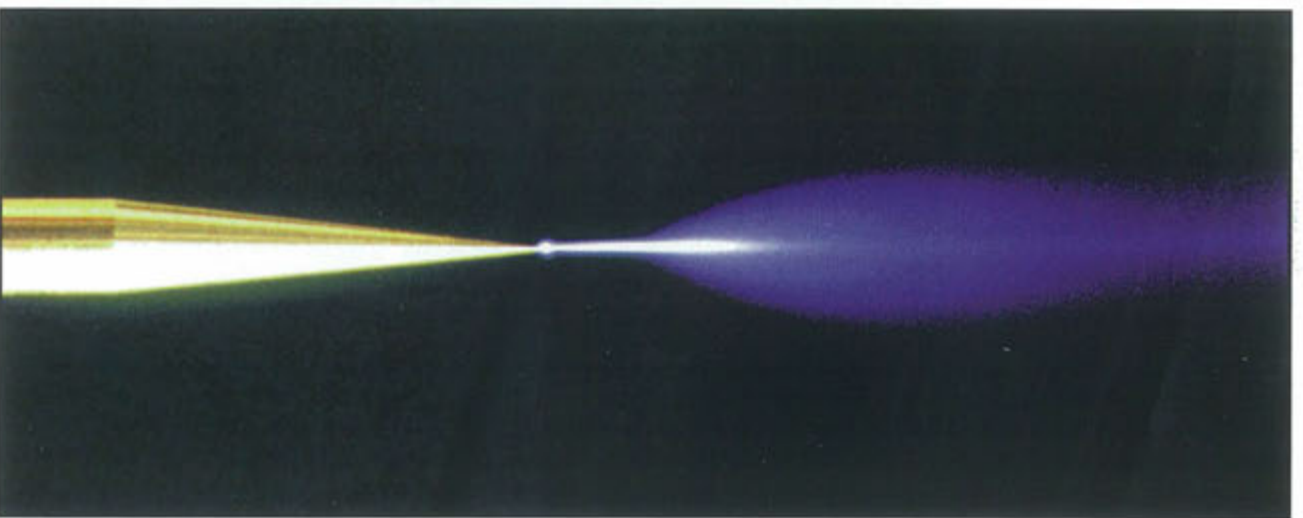

Fig. 14.3: Corona discharge (photo)

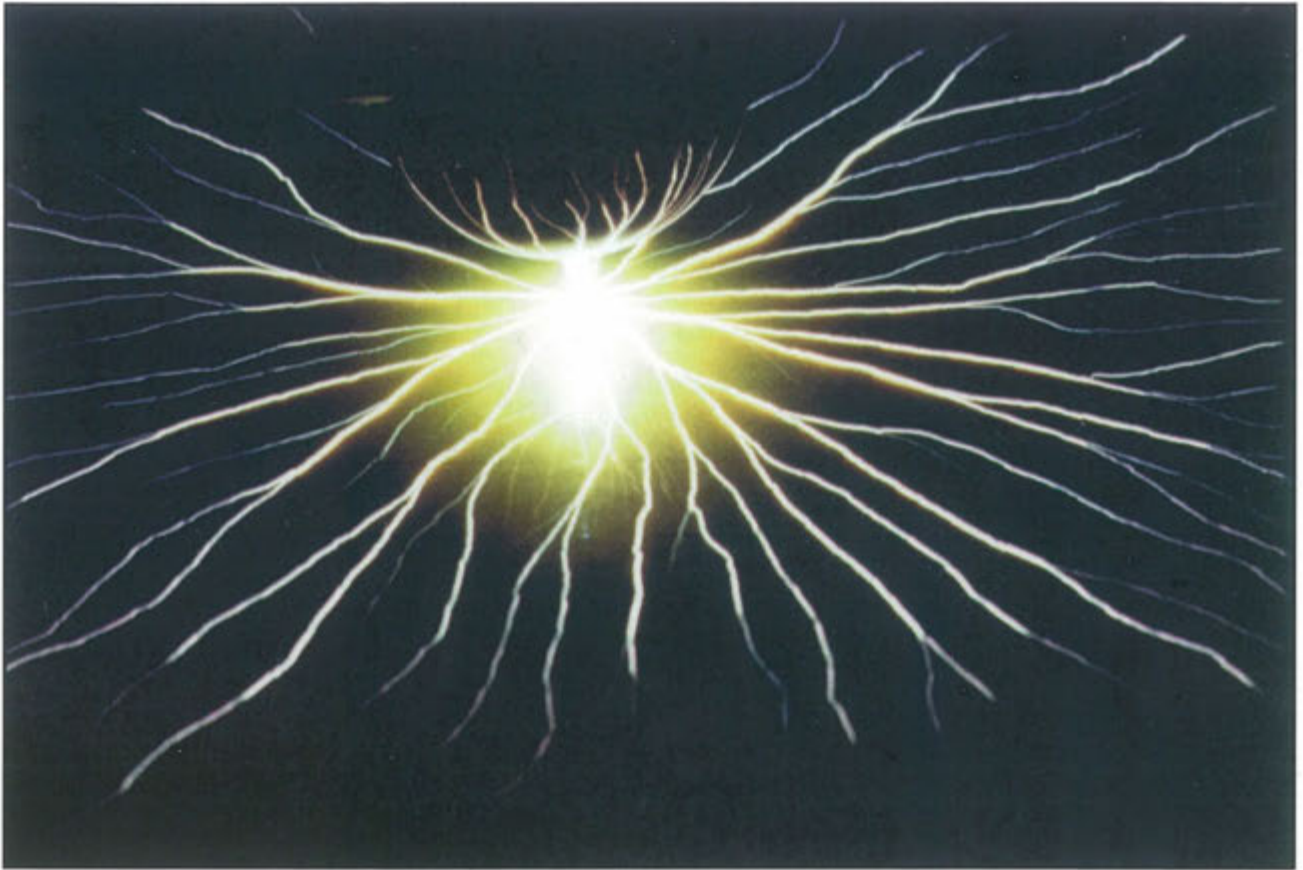
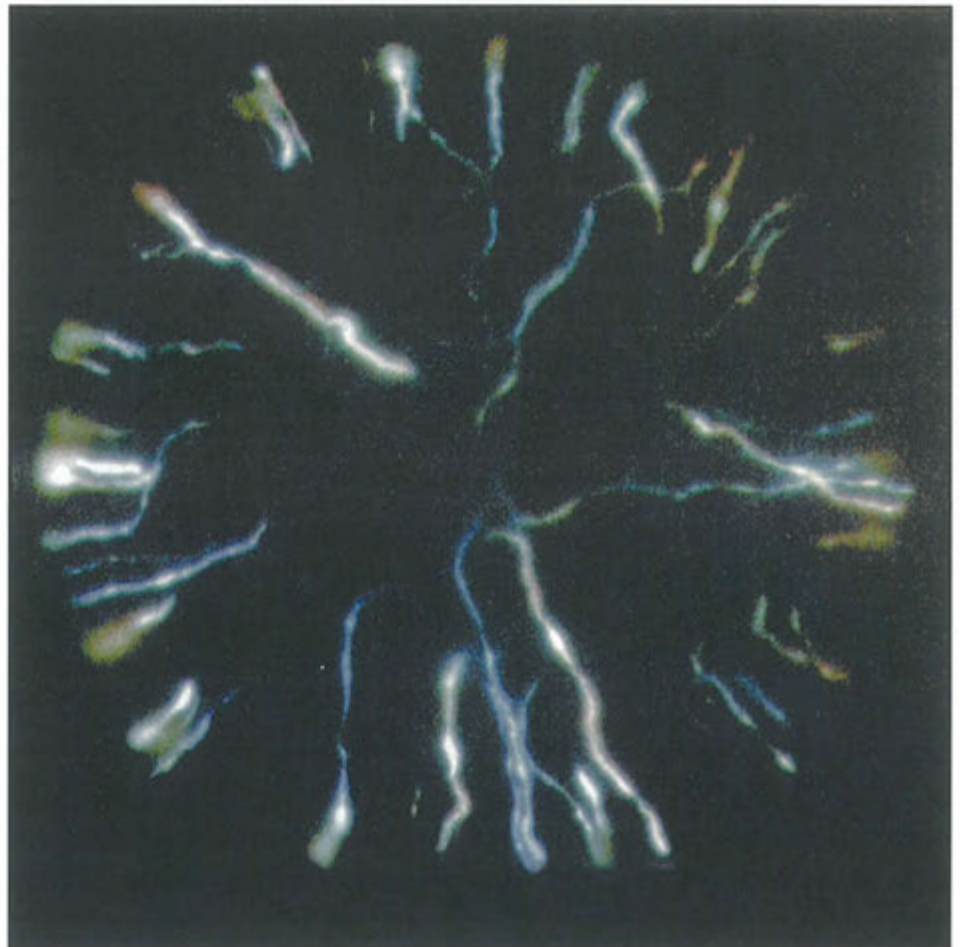

Fig. 14.4: Propagating brush discharge (photo)



*Fig. 14.5:
Cone discharge
(photo)*

3 Constructional explosion protection

Constructional explosion protection measures are necessary if preventive measures implemented with the aim of avoiding explosions do not achieve this goal completely or with sufficient certainty. The use of constructional protection measures does not prevent the occurrence of an explosion. All endangered plant units must therefore be constructed to resist the expected explosion overpressure if an explosion occurs.

The explosion protection measures described in the relevant guidelines [17] - [20] are based on the maximum explosion overpressure measured in closed vessels in accordance with a stipulated procedure. In actual practice, however, it is possible that this value is either not reached (e.g. with increased particle size, deviation from the optimum dust concentration, elevated temperature, increased moisture content of the dust, or partial filling with explosive dust/air mixtures of the equipment to be protected) or exceeded (e.g. with increased initial pressure or elevated oxygen concentration). If the expected explosion overpressure is greater than the maximum explosion overpressure, the former should be taken as the basis in the design stage. If, on the other hand, the expected explosion overpressure is lower than the maximum explosion overpressure, then either the maximum explosion overpressure can be used, or the corresponding expected explosion overpressure.

The following constructional protection measures can be employed:

- explosion-resistant design to withstand the expected explosion pressure
- explosion venting
- explosion suppression

In addition, the transmission of an explosion from plant units protected by constructional measures to other plant units either protected or unprotected - or into work areas - must be prevented. The term used in this connection is

- explosion decoupling (isolation)

This decoupling must be effected as close as possible to the protected equipment.

Where constructional protection measures are used the product inflow, outflow and aspiration should be shut down if an incident occurs.

Which of these methods are applicable to an entire plant or individual plant units must be decided on a case to case basis. However, all parts of the plant which are exposed to a pressure shock if an explosion occurs must always be constructed in a manner which ensures that they can adequately withstand this pressure shock.

3.1 Explosion-resistant design

To safeguard against pressure effects of explosions it is possible to design the vessels and equipment such that they are explosion-resistant to the maximum expected explosion overpressure. Here, additional constructional explosion protection measures - with the exception of explosion decoupling - are not needed. It must be noted, however, that all connected fittings should also be capable of withstanding the expected explosion pressure. In explosion-resistant design, a distinction is made between explosion-pressure-resistant and explosion-pressure-shock resistant [17] design.

A vessel or piece of equipment is explosion-pressure-resistant if it can withstand the expected explosion pressure - not once, but several times - without suffering permanent deformation.

Explosion-pressure-shock resistant vessels or equipment are constructed to withstand the expected explosion overpressure without rupturing, but it is permissible for permanent deformation to result. Here, greater exploitation of the material strength is acceptable.

In the design of explosion-resistant vessels, axially symmetrical parts (i.e. cylindrical or spherical jackets or dished heads) are used as far as possible.

After an explosion - even if no deformation is visible - a check must be made in every case to see if the remaining vessel strength continues to satisfy requirements.

3.2 Explosion venting

In the broadest sense, explosion venting comprises all measures used to vent the initially closed vessel or equipment in a non-hazardous direction, and so prevent the buildup of an inadmissibly high internal pressure when an explosion occurs.

The use of explosion venting presupposes a certain strength of the vessel or equipment and this is achieved by measures defined in Section 3.1 [18]. The reduced explosion overpressure rather than the expected maximum explosion overpressure in the closed vessel or equipment is used as the basis for the calculation, however (Fig. 15). The reduction in pressure is achieved by opening of a venting device, such as bursting disks or explosion doors, with appropriate dimensions.

During the venting process the discharge of combustion gases and dust causes extensive flame and pressure development outside the vessel or equipment to be protected and must be taken into account. When this occurs the external effects can be more violent if the dusts have low K_{St} -values than for dusts with high K_{St} -values. With low K_{St} -values greater quantities of unburnt dust are expelled due to the slower rate of combustion (Figures 16, 17 and 18). Particular attention must also be given to the protection of personnel.

If the protective measures mentioned are applied to vessels or equipment in buildings or other work areas, it is necessary to conduct the pressure relief via a vent duct to a safe place in the open air. In this case, it should be borne in mind that the reduced explosion overpressure is increased in the vessel or equipment to be protected.

The relevant guideline [18] must be observed in the design of explosion venting.

Recoil forces must be taken into account when explosion venting is employed.

Explosion venting may not be used if vented substances are hazardous (e.g. when handling toxic or corrosive substances).

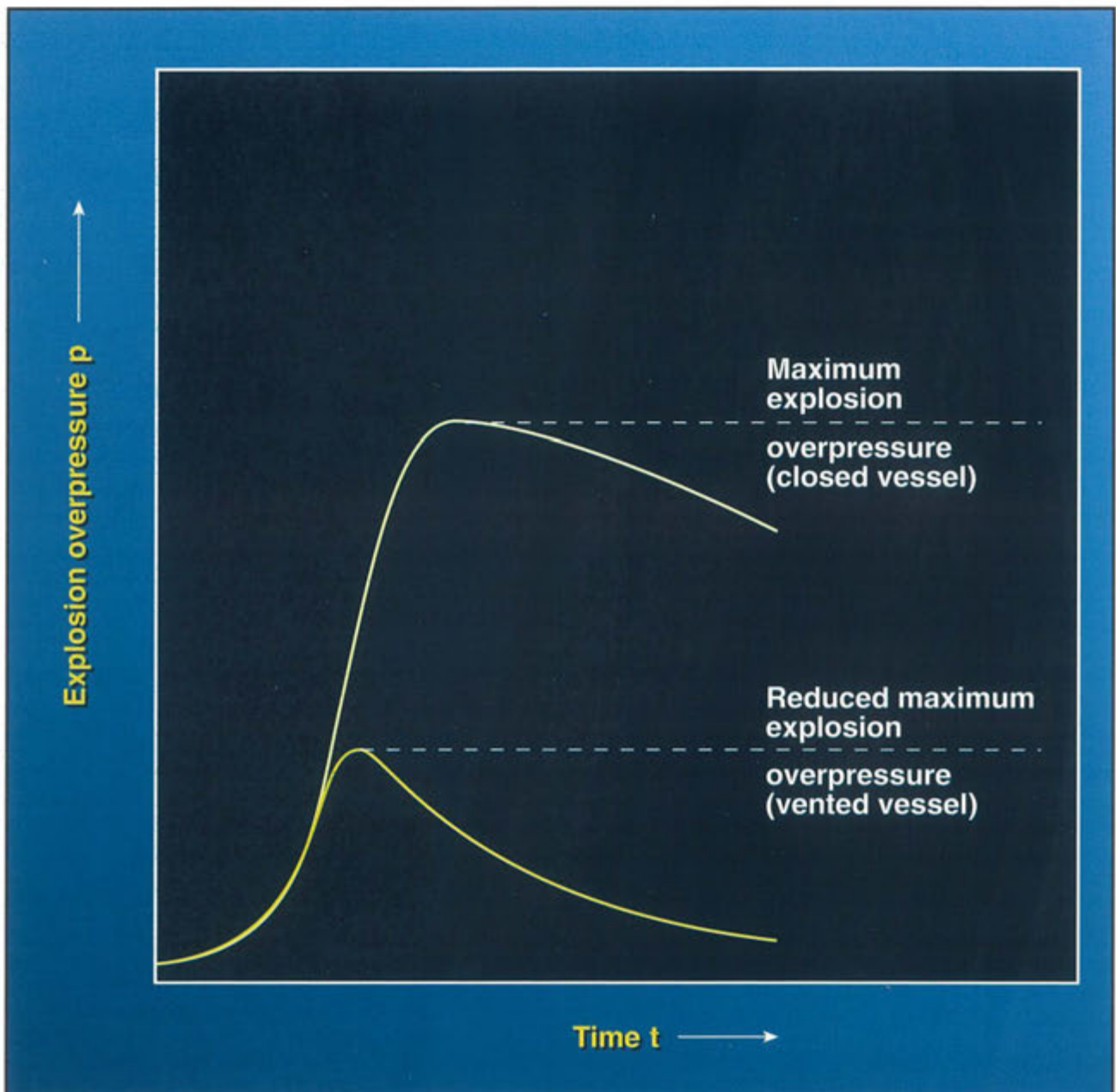

Fig. 15: Profile of a dust explosion with and without the protective measure explosion venting



*Fig. 16: Explosion venting of a 250 m³ vessel
Rapidly developing dust explosion (K_{St} -value = 300 bar · m · s⁻¹)
in a vessel with a small venting area results in a high, reduced
explosion overpressure whereas the pressure generated outside
the vessel is relatively low, despite a long flame jet
(see also Fig. 18)*



Fig. 17: Explosion venting of a 250 m³ vessel
 Less rapidly developing dust explosion (K_{St} -value = 200 bar · m · s⁻¹)
 in a vessel with a large venting area results in a relatively low value
 for the reduced explosion overpressure, but causes a secondary explosion
 outside the vessel with not inconsiderable pressure effects
 (see also Fig. 18)

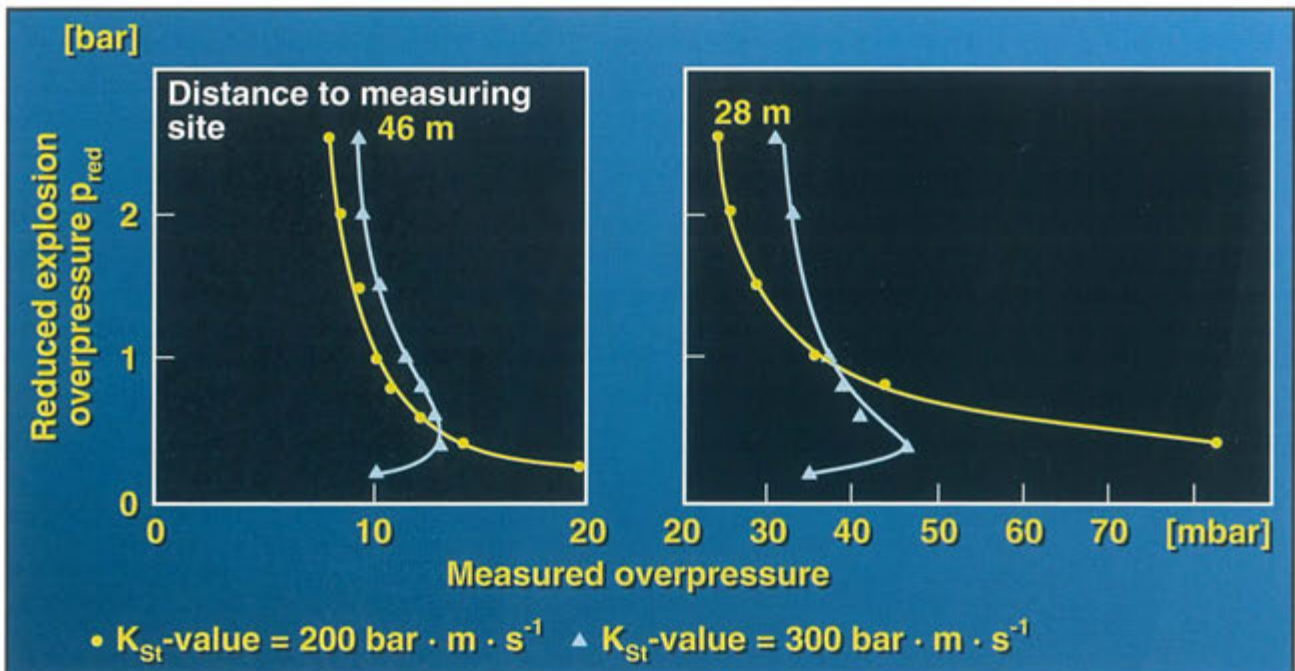

Fig. 18: Explosion venting of a 250 m³ vessel - result of the pressure measurement
 in the free atmosphere

3.3 Explosion suppression

Explosion suppression systems are devices which - as in the case of explosion venting - prevent the buildup of an inadmissibly high pressure during dust explosions in vessels. They function by extinguishing explosion flame during the initial stage of the explosion. The application of this protective measure thus presupposes explosion-resistant design of the equipment - generally for a reduced explosion overpressure of $p_{\text{red}} < 1$ bar [19]. Explosion suppression systems comprise a detection system which registers the developing explosion, and pressurized suppressors whose valves are actuated by the detection system. The suppressant is discharged as quickly as possible into the vessel to be protected and distributed evenly.

Explosion suppression systems should be self-monitoring and retain their ability to function over a certain period of time if power failure occurs. As a rule, explosion suppression systems are effective only with dusts with an explosion overpressure of $p_{\text{max}} \leq 10$ bar and a $K_{\text{St}} \leq 500$ bar · m · s⁻¹. The effectiveness of the suppressant used for the type of dust in question must be established [19], [20]).

3.4 Explosion decoupling, isolation (prevention of explosion propagation)

In all cases where vessels and equipment in plants are connected by pipelines and are exposed to dust explosion hazards, there is a danger that a dust explosion occurring at a particular location in the system can be transmitted to other sites by these pipelines. If such explosion propagation occurs, displacement, turbulence, and pre-compression effects can result in either excessive explosion overpressures or even detonations. A practical solution for prevention of such a transmission involves provision of suitable appliances to shut off certain parts of the plant, i.e. to isolate (decouple) the plant from the explosion.

The use of such decoupling devices is always necessary when:

- an unprotected part of a plant must be safely isolated from the protected part
- or when
- vessels are connected by long pipelines such that the possibility of flame jet ignition or high pressure must be considered. Here, particular problems arise when an explosion in a large vessel can discharge into a smaller vessel or when vessels of relatively high strength are connected to vessels of lower strength.

Depending on the specific situation, isolation can be effected with rotary valves, extinguishing barriers, rapid-action gate valves, rapid-action barrier valves or explosion diverters.

3.4.1 Rotary valves

If dust discharge occurs from explosion-protected vessels or equipment via a rotary valve, this can act like a mechanical barrier against dust explosions, but certain construction features must be taken into consideration.

Rotary valves should only be used when their ability both to prevent the continued propagation of the explosion, and to withstand the mechanical pressure loading of the explosion, have been established in appropriate explosion trials. Experience has shown that a reliable prevention of explosion propagation is achieved when 3 blades on each side are adjacent to the housing, the blades are made of metal at least 2 mm thick, and the clearance between blade and housing ≤ 0.2 mm (Fig. 19). For organic dusts and wettable sulfur only two blades must be adjacent to the housing, provided all other conditions are met.

If only one blade is adjacent to the housing, the clearances must be the same as required for flammable gases. With both gases and dusts, the clearances depend on the ignition temperature of the gas, the minimum ignition temperature of the dust cloud and the minimum ignition energy.

If an explosion occurs, the rotary valve must be immediately stopped to avoid transport of burning or glowing dust.

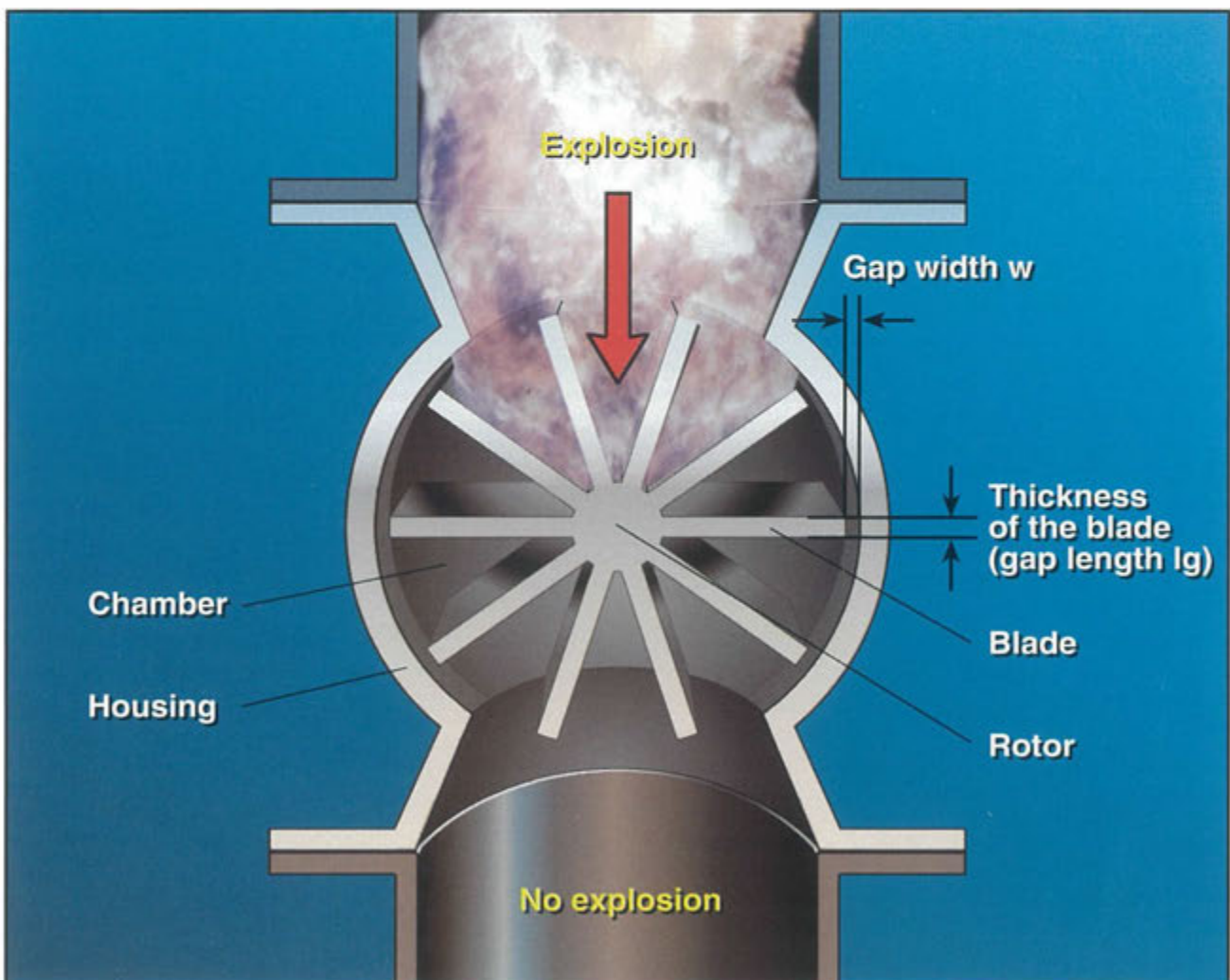

Fig. 19: Rotary valve (active device)

3.4.2 Extinguishing barriers

With an extinguishing barrier, the flame front of an explosion is sensed by a detector which then triggers the injection of the suppressant. The suppressant - preferably an extinguishing powder - is injected within a few milliseconds into the pipeline, and this immediately generates a dense cloud of suppressant in front of the flame and extinguishes it (Fig. 20).

A specified distance depending on the explosion velocity is required between the location of the detector and that of the suppressor to ensure that the suppressant can be injected before the flame front arrives.

The amount of suppressant required is dependent on the type of combustible dust, and on the nominal width of the pipe to be protected, as well as the expected explosion velocity at the site of the extinguishing barrier. Use of such barriers does not reduce the pipe cross-section.

Although the extinguishing procedure eliminates the flames, it does not eliminate the overpressure of the explosion. The strength of the pipework and downstream vessels to be protected must therefore be matched to the expected explosion overpressure or, if applicable, to the reduced explosion overpressure.

Extinguishing barriers shall only be used if they have been proved to be effective.

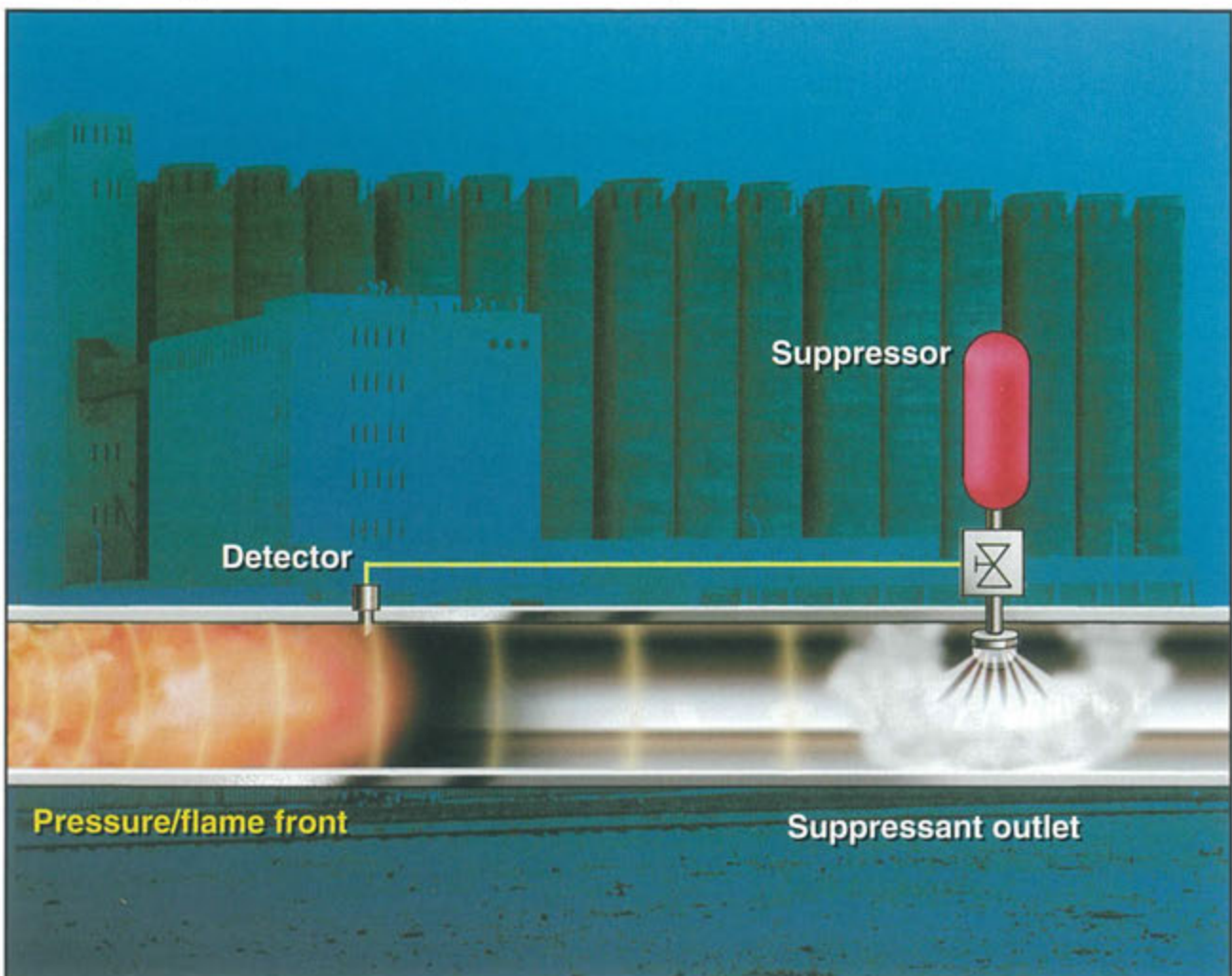

Fig. 20: Extinguishing barrier (active device)

3.4.3 Rapid-action gate valves

Use of rapid-action gate valves to automatically shut off plant units has the advantage that the barrier element of the valve is normally located outside the pipe cross-section. This is thus free of any obstruction and can be constructed without pockets or dead corners to ensure that no deposition of dust occurs (Fig. 21).

The housings of such valves are made of steel, cast steel, or aluminum die castings whereas the slide plate is constructed from high tensile material to ensure lightness and hence short closing times.

As with explosion suppression barrier a minimum distance is required between the explosion detector and the rapid-action gate valve. This depends on the explosion velocity and the valve closing time.

Rapid-action gate valves may only be used when their effectiveness (mechanical strength, closing time, safe ignition-propagation prevention) has been proved.

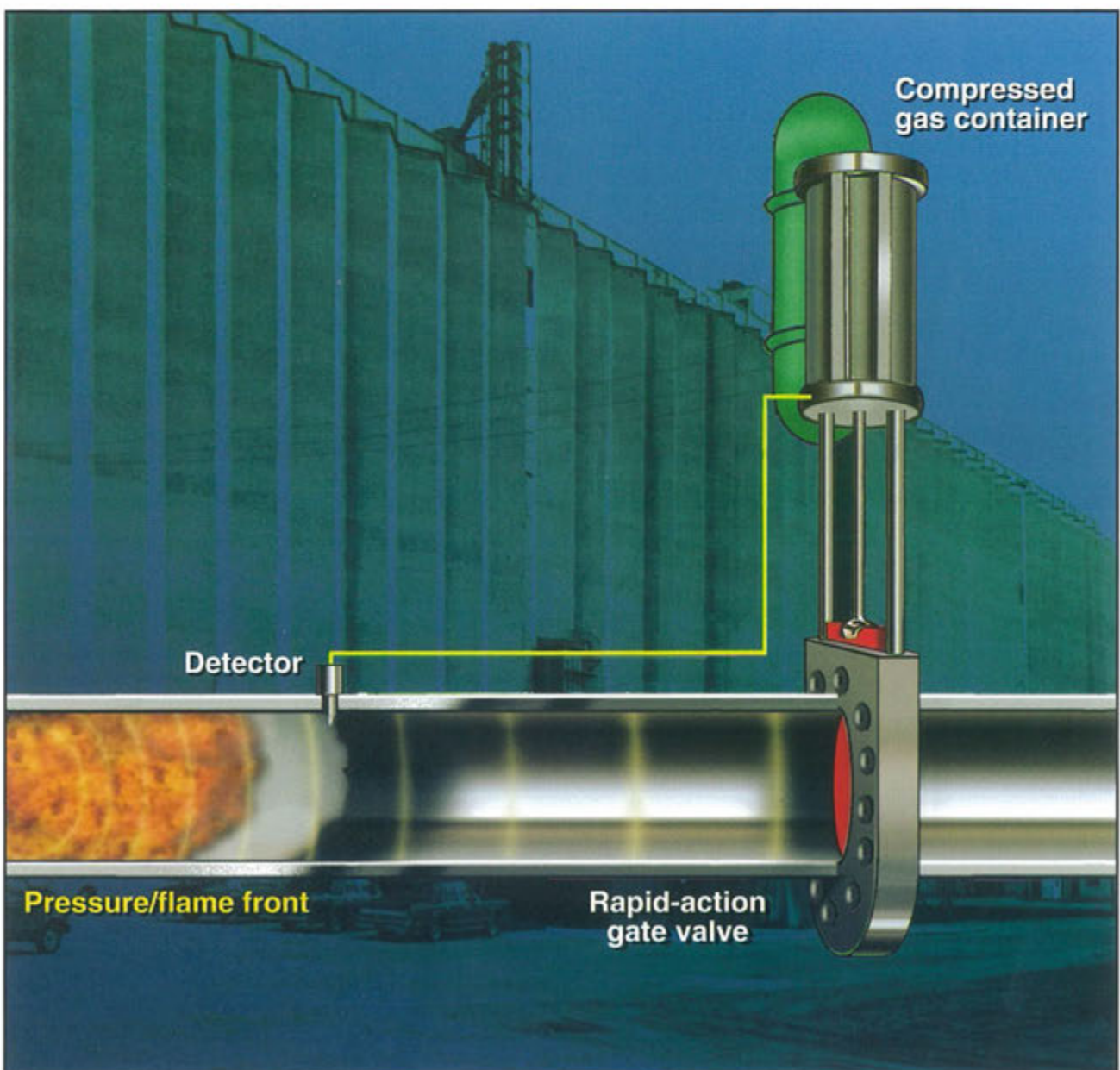

Fig. 21: Rapid-action gate valve (active device)

3.4.4 Rapid-action barrier valves

The rapid-action barrier valve automatically closes when a certain flow velocity is exceeded in the pipeline. Once closed, it can only be released manually. The flow velocity needed to close the valve is either generated by the explosion (passive device, Fig. 22) or by a detector-controlled auxiliary flow (nitrogen discharge onto the valve poppet, active device, Fig. 23). Rapid-action barrier valves currently available are suitable only for lines with a relatively small dust loading (e.g. clean air side of filter units).

Rapid-action barrier valves may only be used when their effectiveness (mechanical strength, closing time, safe ignition-propagation prevention) has been proved.

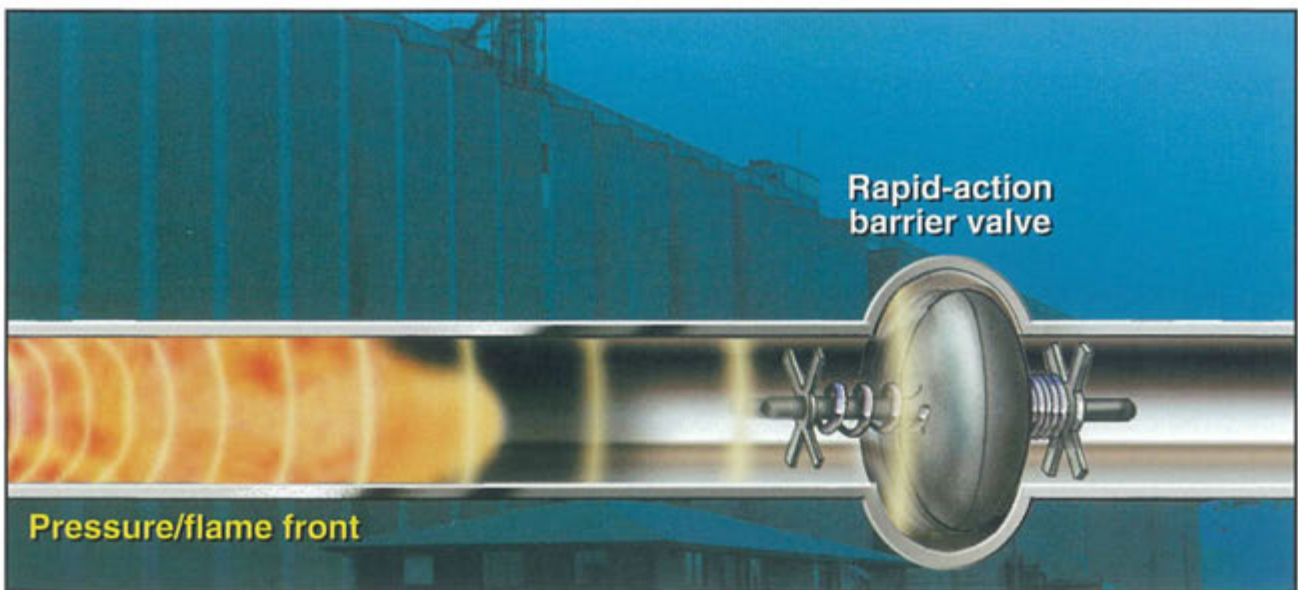

Fig. 22: Rapid-action barrier valve (passive device)

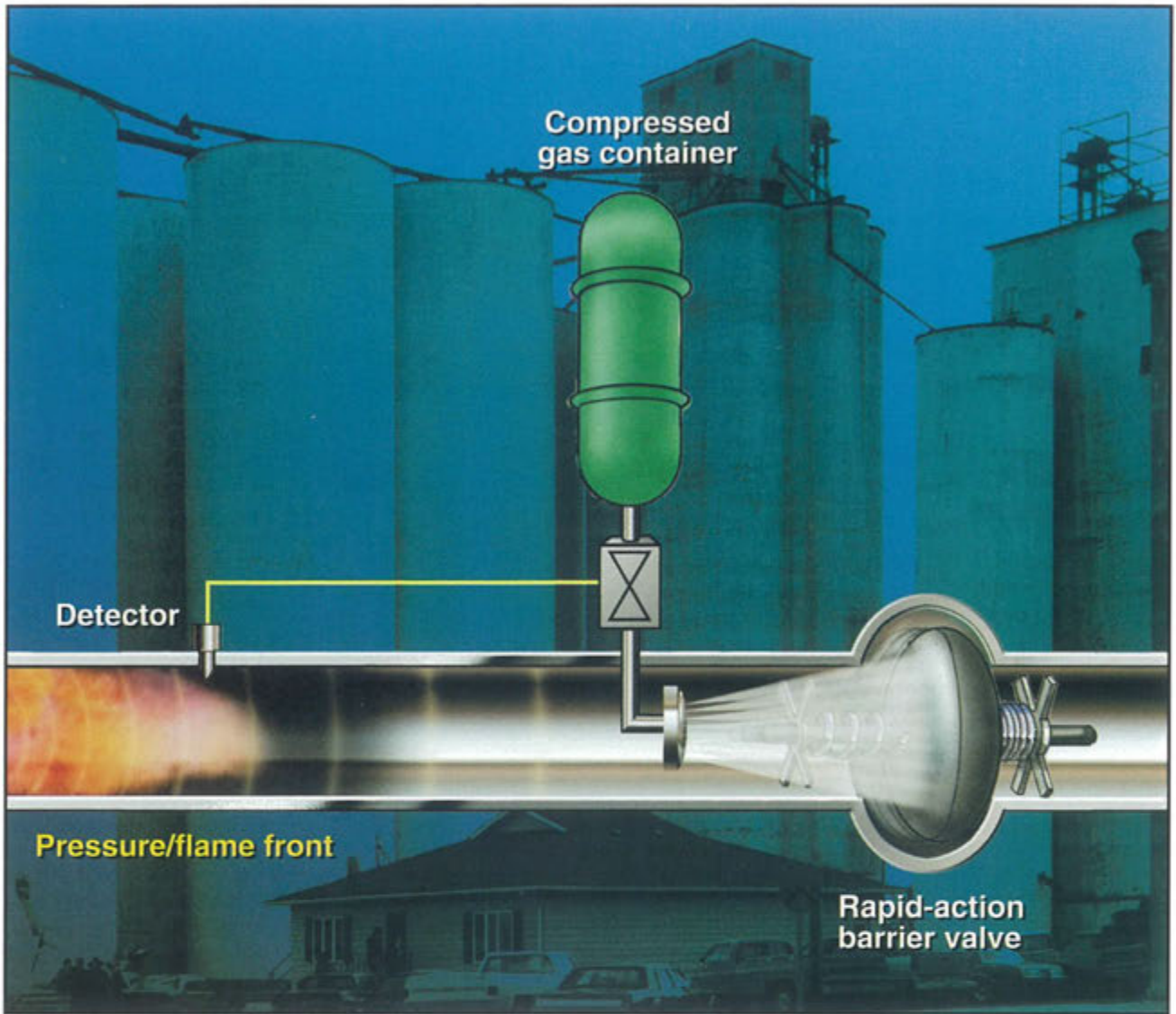

Fig. 23: Rapid-action barrier valve (active device)

3.4.5 Explosion diverters

An explosion diverter consists of pipeline parts which are connected to one another with a special pipe section (Fig. 24). A cover or bursting disc (static activation overpressure < 0.1 bar) is used to seal the end of the pipe from the atmosphere. An explosion transmission should be prevented by the 180 degree change in flow direction together with simultaneous explosion venting of the pipe.

Parts must not fly off and this can be avoided by use, for example, of a guard cage. Venting must be effected in such a manner that no hazard is caused by pressure or the emergence of flames.

The effectiveness of the explosion diverter depends on the characteristics of the specific explosion (violence, direction, etc.). For example, an extract ventilation pipe can be safely isolated if

- under operational conditions there are no explosive dust concentrations at the dust extract point, or in the piping system

and

- the aim is only to prevent transmission of an explosion from the dust collector into the piping system.

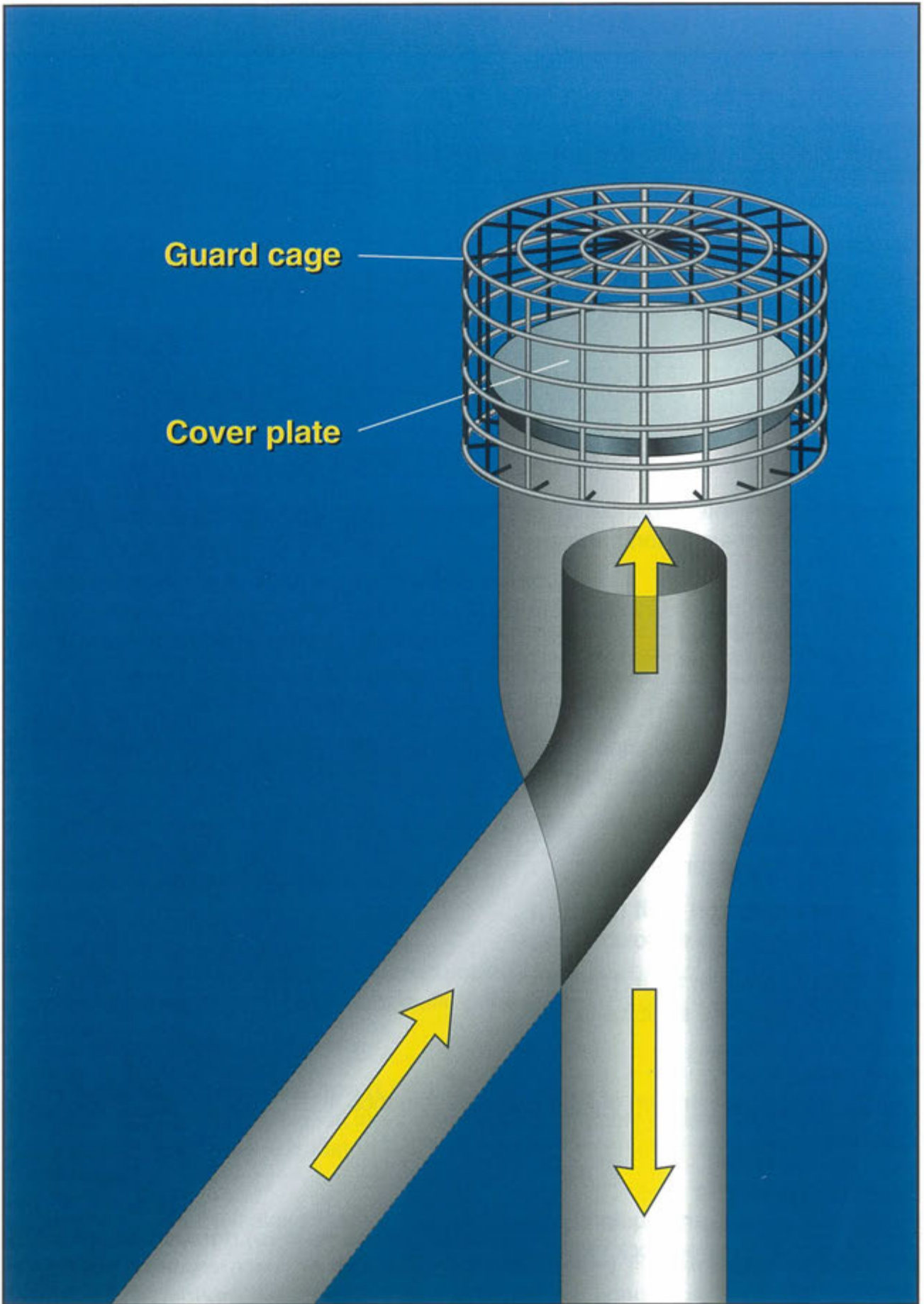

Fig. 24: Explosion diverter with cover plate (passive device)

4 Appendix

4.1 Terms, definitions and abbreviations [25]

Combustible dust

Dust, fibres or flyings that can burn or glow in air and could form explosive mixtures with air at atmospheric pressure and normal temperatures.

Cubic law

The dependence on the vessel volume of the maximum rate of explosion pressure rise:

$$(dp/dt)_{\max} \cdot V^{1/3} = \text{constant} = K_{St}$$

Because of this interdependency between volume V and $(dp/dt)_{\max}$, values of the maximum rate of explosion pressure rise must be accompanied by volume data.

Deflagration

Explosion propagating at subsonic velocity.

See also "Spontaneous decomposition".

Explosion

Abrupt oxidation or decomposition reaction producing an increase in temperature, pressure, or in both simultaneously.

Explosion limits

Limits of explosion range.

Lower explosion limit (LEL)

Lower limit of the explosion range.

Upper explosion limit (UEL)

Upper limit of the explosion range.

Explosion range

Range of the concentration of a flammable substance in air, within which an explosion can occur.

Explosion-resistant

Property of vessels and equipment designed to be either explosion-pressure-resistant or explosion-pressure-shock resistant.

Explosion-pressure-resistant

Property of vessels and equipment designed to withstand the expected explosion pressure without becoming permanently deformed.

Explosion-pressure-shock resistant

Property of vessels and equipment designed to withstand the expected explosion pressure without rupturing, but allowing permanent deformation.

Glow temperature (GT)

Minimum ignition temperature of a dust layer of 5 mm thickness ($MIT_{L=5\text{mm}}$).

Hybrid mixture

Mixture of flammable substances with air in different physical states.

NOTE Examples for hybrid mixtures are mixtures of methane, coal dust and air or mixtures of gasoline vapour and gasoline droplets with air.

Ignition source

Any source with sufficient energy to initiate combustion

Ignition temperature of an explosive atmosphere

Lowest temperature of a heated surface at which, under specified conditions the ignition of an explosive atmosphere will occur.

NOTE Is only applicable to gas and vapour. For dust, see "(minimum) ignition temperature of a dust cloud"

Inert gas

Non-flammable gas which will not support combustion and does not react to produce a flammable gas.

Initial pressure (p_o)

Pressure prevailing before the explosion.

 K_{St} -value

A volume-independent parameter characterizing the explosibility of a dust and calculated from the cubic law. The K_{St} -value is specific to the dust and is determined under standard conditions.

Limiting oxygen concentration (LOC)

Maximum oxygen concentration in a mixture of a flammable substance and air and an inert gas, in which an explosion will not occur, determined under specified test conditions.

Maximum explosion (over)pressure (p_{max})

Maximum pressure occurring in a closed vessel during the explosion of a specific explosive atmosphere determined under specified test conditions.

Maximum rate of explosion pressure rise ($(dp/dt)_{max}$)

Maximum value of the pressure rise per unit time during the explosion of a specific explosive atmosphere in a closed vessel under specified test conditions.

Median value (M)

Value of the median particle size. 50 wt % of the dust is coarser and 50 wt % finer than the median value.

Minimum ignition energy (MIE)

Lowest energy which is sufficient to effect ignition of the most easily ignitable explosive atmosphere under specified test conditions.

(Minimum) ignition temperature of a dust cloud (MIT_C)

Lowest temperature of the hot inner wall of a furnace at which ignition occurs in a dust cloud in air contained therein.

NOTE When carrying out this test, it is essential that all necessary precautions be taken to safeguard the health of personnel, for example, against the risk of fire, explosion, inhalation of smoke or any toxic products of combustion.

Minimum ignition temperature of a dust layer (MIT_L)

Lowest temperature of a hot surface at which ignition occurs in a dust layer of specified thickness on this hot surface (see glow temperature).

NOTE 1 Because of the wide range of processes in industry, the ignition of dust layers may be dependent upon local conditions. This method of test is not necessarily representative of all industrial conditions, where account may need to be taken of such factors as the presence of thick layers of dust and of the distribution of temperature in environment.

NOTE 2 When carrying out this test, it is essential that all necessary precautions be taken to safeguard the health of personnel, for example, against the risk of fire, explosion, inhalation of smoke or any toxic products of combustion.

Recoil force

Force acting against the direction of outflow when explosion venting takes place.

Reduced explosion (over)pressure (p_{red})

Pressure generated by an explosion of an explosive atmosphere in a vessel, protected by either explosion relief or explosion suppression.

Smoldering agglomerates

Glowing, i.e. flameless oxidizing part of a deposit of flammable material. Smoldering agglomerates can be generated by spontaneous heating or by external ignition sources.

Spontaneous decomposition ("deflagration")

A decomposition reaction which is ignited locally by an external source and, in contrast to combustion, propagates independently even when atmospheric oxygen is excluded.

Static electricity

See ISSA brochure *Static Electricity - Ignition hazards and protection measures* [13].

4.2 References

- [1] Commission of the European Community, Directive 94/9/EC of the European Parliament and the Council dated March 23, 1994, for the harmonization of the legal regulations of member states *for devices and protective systems designated for use in areas subject to explosion hazards*, published in the Official Journal of the EC, L 100, dated August 19, 1994, pages 1-29 (ATEX 100a, new ATEX 95).
- [2] Commission of the European Community, Directive 1999/92/EC of the European Parliament and the Council dated December 16, 1999, *on minimum requirements for improving the safety and health of workers potentially at risk from explosive atmospheres* (15th individual directive within the meaning of Article 16(1) of Directive 89/391/EEC), Official Journal of the EC, L 023, dated January 28, 2000, pages 57-64 (ATEX 118a, new ATEX 137).
- [3] EN (European Standard), *Explosive Atmosphere - Explosion Protection - Part 1: Basics and Methodology*, EN 1127-1, August 1997. ¹⁾
- [4] Bartknecht W., *Dust Explosions, Course, Prevention, Protection*, Springer Verlag, D-10969 Berlin, 1989.
- [5] ESCIS (Expert Commission for Safety in the Swiss Chemical Industry), *Risk Analysis*, ESCIS Brochure 4, Suva, Chemistry Section, CH-6002 Lucerne, 2000.
- [6] ESCIS, *Safety Tests for Chemicals* (only available in German), ESCIS Brochure 1, Suva, Chemistry Section, CH-6002 Lucerne, 1998.
- [7] ISSA (International Social Security Association), *Dust Explosions - Protection against explosions due to flammable dusts*, International Section on the Prevention of Occupational Risks and Diseases in the Chemical Industry of the ISSA, BG Chemie, D-69115 Heidelberg, 2003.
- [8] ISSA, *Determination of the Combustion and Explosion Characteristics of Dusts*, International Section of the ISSA for Machine and System Safety, BGN, D-68165 Mannheim, 1997.
- [9] ESCIS, *Inerting*, ESCIS Brochure 3, Suva, Chemistry Section, CH-6002 Lucerne, 1995.
- [10] VDI (Verein Deutscher Ingenieure - The Association of Engineers), *Inerting*, VDI Guideline 2263 - Part 2, VDI Verlag, D-40239 Düsseldorf, 1992.
- [11] ESCIS, *Static Electricity - Rules for Plant Safety*, ESCIS Brochure 2, Suva, Chemistry Section, CH-6002 Lucerne, 2004.
- [12] ESCIS, *Static Electricity - Ignition Hazards and Safety Measures*, an Interactive Tutorial, CD-ROM V1.2e, Suva, Chemistry Section, CH-6002 Lucerne, 2002.

¹⁾ For further EN standards see also www.cenorm.be/catweb/cwen.htm

- [13] ISSA, *Static Electricity - Ignition Hazards and Protection Measures*, International Section on the Prevention of Occupational Risks and Diseases in the Chemical Industry of the ISSA, BG Chemie, D-69115 Heidelberg, 1996.
- [14] ESCIS, *Milling of Combustible Solids*, ESCIS Brochure 5, Suva, Chemistry Section, CH-6002 Lucerne, 1993.
- [15] ESCIS, *Drying of Solids*, ESCIS Brochure 6, Suva, Chemistry Section, CH-6002 Lucerne, 2003.
- [16] ESCIS, *Protection Against Material Release as a Consequence of Emergency Pressure Relief* (only available in German), ESCIS Brochure 12, Suva, Chemistry Section, CH-6002 Lucerne, 1996.
- [17] VDI, *Explosion Shock Resistant Construction - Calculation, Design and Testing*, VDI Guideline 2263 - Part 3, VDI Verlag, D-40239 Düsseldorf, 1980.
- [18] VDI, *Pressure Venting of Dust Explosions*, VDI Guideline 3673 - Part 1, VDI Verlag, D-40239 Düsseldorf, 2002
- [19] VDI, *Suppression of Dust Explosion*, VDI Guideline 2263 - Part 4, VDI Verlag, D-40239 Düsseldorf, 1992
- [20] VDI, *Explosion Protection in Fluid Bed Dryers, Hints and Examples of Operation*, VDI Guideline 2263 - Part 5 and Part 5.1, VDI Verlag, D-40239 Düsseldorf, 2003
- [21] HVBG (Hauptverband der gewerblichen Berufsgenossenschaften, Federation of the Statutory Accident Insurance Institutions of the Industrial Sector), *Dokumentation Staubexplosionen - Analyse und Einzelfalldarstellung* (only available in German), *BIA-Report 11/97*, HVBG, D-53754 Sankt Augustin, 1997.
- [22] Eckhoff R.K., *Dust Explosions in the Process Industries*, Butterworth - Heinemann, Oxford, 2003.
- [23] Suva (Swiss National Accident Insurance Fund), *Explosions - Risks and Explosion Protection Measures* (only available in German, French and Italian), an Interactive Tutorial, CD-ROM Nr. 99065, Suva, Chemistry Section, CH-6002 Lucerne, 2003.
- [24] HVBG, *Combustion and Explosion Characteristics of Dusts*, *BIA-Report 13/97*, HVBG, D-53754 Sankt Augustin, 1997.
- [25] EN, *Potentially Explosive Atmospheres - Terms and Definitions for Equipment and Protective Systems Intended for Use in Potentially Explosive Atmospheres*, EN 13237, June 2003.
- [26] ESCIS, *Explosion Protection - Safety Characteristics and Risk Analysis, Preventive Measures, Constructional Measures*, Video Series Part 1-4, Suva, Chemistry Section, CH-6002 Lucerne, 1999.

5 ISSA publications on explosion protection

IVSS

ISSA "Machine and System Safety" Section
"Dust Explosions" Working Party

Dust Explosion Prevention and Protection for Machines and Equipment

- Basic Principles (Engl./Ger.)
(2004)
- Examples (Ger./Engl./Fr.)
(1990)

Explosion Suppression (Engl./Ger./Fr.)
(1990)

Determination of the Combustion and Explosion Characteristics of Dusts (Engl./Ger.)
(1995)

Explosion Decoupling (Ger./Engl.)
(In preparation)

Address for orders: ISSA "Machine and System Safety" Section
Dynamostrasse 7-11
D-68165 Mannheim
Germany

IVSS

ISSA "Chemical Industry" Section
"Explosion Protection" Working Party

Dust Explosion (Engl./Ger./It.)
(2003)

Protection against explosions due to mixtures of flammable gases, vapors, or mists with
air (Engl./Ger./It.)
(2002)

Safety of Liquid Gas (Propane und Butane) (Engl./Ger./Fr./It./Span.)
(1992)

Static Electricity - Ignition hazards and protection measures (Engl./Ger./Fr./It.)
(1996)

Ignition Sources (in preparation)

Address for orders: ISSA "Chemistry" Section
PO Box 10 14 80
D-69004 Heidelberg
Germany

THE ISSA AND THE PREVENTION OF OCCUPATIONAL ACCIDENTS AND DISEASES

The ISSA Permanent Committee on the Prevention of Occupational Risks and Diseases brings together occupational safety specialists from all over the world. It promotes international cooperation in this field, and undertakes special studies on topics such as the role of the press, radio, and television in occupational safety, and integral strategies for the workplace, road traffic, and the home. It also coordinates the activities of the eight international sections for the prevention of occupational risks and diseases, which are active in various industries and in agriculture, and which have their secretariats in various different countries. Three further sections are concerned with information technology in the field of occupational safety, with relevant research, and with education and training for the prevention of occupational accidents and diseases.

The activities of the international sections of the ISSA comprise:

- the international exchange of information between bodies concerned with the prevention of occupational risks
- the organization of meetings of committees and working parties, round-table discussions, and colloquia at the international level
- the performance of surveys and studies
- the promotion of research
- the publication of pertinent information

Further information relating to these activities and the general work of the ISSA in the field of occupational safety can be found in the leaflet "*Safety for Everyone*". It is available in English, German, French, and Spanish from the office of the general secretariat in Geneva.

MEMBERSHIP OF THE INTERNATIONAL SECTIONS

Each international section of the ISSA has three categories of member:

- Full Member
Full members and associate members of the ISSA, Geneva, and other nonprofit organizations can apply for membership as a Full Member
- Associate Member
Other organizations and companies can become Associate Members of a section if they have specialized knowledge of the area for which the section is responsible
- Correspondent
Individual experts can become Corresponding Members of a section

Further information and application forms are available directly from the secretariats of the individual sections.

**AT LEAST ONE OF THESE ISSA SECTIONS ON THE PREVENTION OF
OCCUPATIONAL RISKS CORRESPONDS TO YOUR OWN FIELD OF INTEREST:
DO NOT HESITATE TO CONTACT ITS SECRETARIAT**



ISSA INTERNATIONAL SECTION
for AGRICULTURE
Bundesverband der landwirtschaftlichen
Berufsgenossenschaften
Weissensteinstrasse 72
DE-34131 KASSEL-WILHELMSHÖHE
Germany



INTERNATIONAL SECTION of the ISSA
FOR MACHINE and SYSTEM SAFETY
Berufsgenossenschaft
Nahrungsmittel und Gaststätten
Dynamostr. 7-11
DE-68165 MANNHEIM
Germany



ISSA INTERNATIONAL SECTION
for the CHEMICAL INDUSTRY
Berufsgenossenschaft
der chemischen Industrie
Kurfürsten Anlage 62
DE-69115 HEIDELBERG
Germany



ISSA INTERNATIONAL SECTION
for the MINING INDUSTRY
Bergbau-Berufsgenossenschaft
Hunscheidtstrasse 18
DE-44789 BOCHUM
Germany



ISSA INTERNATIONAL SECTION
for the CONSTRUCTION INDUSTRY
Caisse régionale d'assurance-maladie
d'Île de France
17-19, place de l'Argonne
FR-75019 PARIS
France



ISSA INTERNATIONAL SECTION
for RESEARCH
Institut National de Recherche
et de Sécurité (INRS)
30, rue Olivier-Noyer
FR-75680 PARIS CEDEX 14
France



ISSA INTERNATIONAL SECTION
for ELECTRICITY - GAS -
LONG-DISTANCE HEATING - WATER
Berufsgenossenschaft
der Feinmechanik und Elektrotechnik
Gustav Heinemann Ufer 130
DE-50968 COLOGNE
Germany



ISSA INTERNATIONAL SECTION
for EDUCATION and TRAINING
Institut National de Recherche
et de Sécurité (INRS)
30, rue Olivier-Noyer
FR-75680 PARIS CEDEX 14
France



ISSA INTERNATIONAL SECTION
for INFORMATION
Institut pour la prévention, la protection
et le bien-être au travail (PREVENT)
88, rue Gachard, Boîte 4
BE-1050 BRUXELLES
Belgium



ISSA INTERNATIONAL SECTION
for HEALTH SERVICES
Berufsgenossenschaft für
Gesundheitsdienst und
Wohlfahrtspflege (BGW)
Pappelallee 35-37
DE-22089 HAMBURG
Germany



ISSA INTERNATIONAL SECTION
for the IRON AND METAL INDUSTRY
Allgemeine Unfallversicherungsanstalt
Adalbert-Stifter-Strasse 65
AT-1200 VIENNA XX
Austria
